

01-10-2003

Form PTO-1594  
(Rev. 10/02)  
OMB No. 0651-0027 (exp. 6/30/2005)  
Tab settings ⇌ ⇌ ⇌ ▼



U.S. DEPARTMENT OF COMMERCE  
U.S. Patent and Trademark Office

102334256 ▼ ▼ ▼

To the Honorable Commissioner of Patents and Trademarks: Please record the attached original documents or copy thereof.

1. Name of conveying party(ies):

Crane Co.

1-8-03

- Individual(s)
- General Partnership
- Corporation-State Delaware
- Other \_\_\_\_\_
- Association
- Limited Partnership

Additional name(s) of conveying party(ies) attached?  Yes  No

2. Name and address of receiving party(ies)

Name: CR/PL, L.L.C.

Internal

Address: \_\_\_\_\_

Street Address: 1235 Hartrey Avenue

City: Evanston State: IL Zip: 60202

- Individual(s) citizenship \_\_\_\_\_
- Association \_\_\_\_\_
- General Partnership \_\_\_\_\_
- Limited Partnership \_\_\_\_\_
- Corporation-State \_\_\_\_\_
- Other Delaware limited liability company

If assignee is not domiciled in the United States, a domestic representative designation is attached:  Yes  No  
(Designations must be a separate document from assignment)  
Additional name(s) & address(es) attached?  Yes  No

3. Nature of conveyance:

- Assignment
- Security Agreement
- Other \_\_\_\_\_
- Merger
- Change of Name

Execution Date: 10/03/2001

4. Application number(s) or registration number(s):

A. Trademark Application No.(s) \_\_\_\_\_

B. Trademark Registration No.(s) 2151790;

1650700; 998950

Additional number(s) attached  Yes  No

5. Name and address of party to whom correspondence concerning document should be mailed:

Name: Lawrence A. Swain, Esq.

Internal Address: Shughart Thomson & Kilroy PC

Street Address: 9225 Indian Creek Parkway

Suite 1100

City: Overland Park State: KS Zip: 66210

6. Total number of applications and registrations involved: 3

7. Total fee (37 CFR 3.41).....\$ 90.00

- Enclosed
- Authorized to be charged to deposit account

8. Deposit account number:

DO NOT USE THIS SPACE

9. Signature.

Lawrence A. Swain, Esq.

Name of Person Signing

  
Signature

12-30-02

Date

Total number of pages including cover sheet, attachments, and document: 26

01/09/2003 LMUELLER 00000269 2151790

Mail documents to be recorded with required cover sheet information to:  
Commissioner of Patent & Trademarks, Box Assignments  
Washington, D.C. 20231

01 FC:8521  
02 FC:8522

40.00 OP  
50.00 OP

TRADEMARK  
REEL: 002646 FRAME: 0057

TRADEMARK ASSIGNMENT, LICENSE TERMINATION  
AND WORLDWIDE TRADEMARK CO-EXISTENCE AGREEMENT

This Trademark Assignment, License Termination and Worldwide Trademark Co-Existence Agreement ("Agreement") is entered into as of this 3rd day of October, 2001 (the "Effective Date") by and between:

CRANE CO., a Delaware corporation, with its principal place of business at 100 First Stamford Place, Stamford, Connecticut (hereinafter "Crane")

a

n

d

CR/PL, L.P., an Illinois limited partnership, with its main office and principal place of business in Evanston, Illinois (hereinafter "CR/PL").

RECITALS

WHEREAS, on or about July 11, 1984, Crane sold certain assets used in its United States based Plumbing Business to CR/PL's predecessor-in-interest pursuant to an Agreement For Purchase And Sale of Assets (the "Asset Sale Agreement");

WHEREAS, the Asset Sale Agreement included a license from Crane to CR/PL to use the trademark CRANE but only in the form of the composite mark "Crane Plumbing" and certain ancillary marks (the "Ancillary Marks") exclusively in the United States and non-exclusively in other countries of the world, except Canada, the terms and conditions of which are set forth in Article 4 thereof (the "License");

WHEREAS, disputes arose between the parties, and/or their subsidiaries, affiliates and divisions (collectively "Affiliated Companies") concerning whether certain

events, occurrences and/or practices violated the License and/or applicable trademark laws;

WHEREAS, one such dispute involving use of the "Crane Plumbing" composite mark in Canada was settled by execution of an agreement dated October 30, 1990 between Crane Canada Inc. ("Crane Canada"), a subsidiary of Crane, on the one hand, and CR/PL and its subsidiary Fiat Products, Ltd. ("Fiat"), on the other (the "1990 Settlement Agreement");

WHEREAS, other disputes arose between the parties concerning similar issues, and were settled by execution of an agreement dated May 31, 1996, (the "1996 Settlement Agreement") by which the 1990 Settlement Agreement was terminated and the License was amended;

WHEREAS, CR/PL has agreed to purchase, and Crane Canada has agreed to sell, the assets relating to the business carried on by Crane Canada's plumbing division, including certain intellectual property rights related thereto, under an Asset Purchase Agreement dated as of even date herewith (the "APA"); and

WHEREAS, the parties desire to enter into this Agreement, simultaneously and in coordination with execution of the APA, in order to assign the trademark rights previously licensed by Crane to CR/PL, to terminate the License and to establish, as between Crane, and its Affiliated Companies, including Crane Canada, Inc., on the one hand, and CR/PL, and its Affiliated Companies, on the other, their respective trademark rights in the mark CRANE on a worldwide basis and to provide for the co-existence of their respective trademark rights in the future in such a way as to protect both party's existing and prospective trademark rights and registrations,

including such rights as against third parties, and to avoid any likelihood of confusion as between one another, their use of the CRANE mark and their respective businesses.

NOW THEREFORE, in consideration of the mutual promises and covenants set forth in this Agreement, and for the other considerations set forth herein, Crane and CR/PL, each intending to be legally bound hereby, agree as follows:

## ARTICLE I

### Definitions

1.1. "Plumbing Products" means *plumbing fittings*, namely faucets, bibbs, strainers, valves, including flush valves, mixing valves, ball cocks and supply valves, outlets, traps, lavatory and sink traps, escutcheons, all made of brass, cast iron, malleable iron or other alloys; *plumbing fixtures*, namely, lavatories, bath tubs, laundry tubs, showers, tub showers, free-standing showers, shower floors, floor drains, water closets, including tanks and lids, bidets, and urinals, sinks, bathroom and kitchen sinks, floor sinks, service sinks, hospital lavatories, sitz baths, mop basins, saunas, steam rooms, steam suites, whirlpools, hot tubs, water fountains, drinking fountains, and for non-industrial applications only - garbage disposals, hot water dispensers, water softeners and purifiers, electric/electronic controls for faucets and whirlpools, water heaters and steam generators; *bathroom trimmings*, namely, shower and toilet partitions, shower doors, railings, bowl wax, shelves, vanities, medicine chests, bathroom hooks, trashcans, towel bars, holders and containers for toothbrushes, cups, soap, razors, cotton balls, and other bathroom items, all made of cultured marble, stone, ceramic, vitreous china, plastic, composites, glass, metal, wood, laminate, terrazzo, fiberglass, gel-coated fiberglass, cast iron, or other suitable materials, all of which

generally fall within International Classes 11, of the United States Trademark Office's Identification of Goods and Services Manual; replacement parts and fittings for the above goods; and such other products within International Class 11 that are functionally related to plumbing fittings, plumbing fixtures, and bathroom trimmings as described above.

## ARTICLE II

### Assignment of Trademark Rights

2.1. Crane agrees to, and hereby does, assign to CR/PL United States Trademark Registrations No. 1,650,700 (the "Bird Logo") and 2,151,790 No. (the "Crane Plumbing" composite mark) together with the goodwill of the business represented thereby for use only in connection with the manufacture and sale of Plumbing Products.

2.2. Crane agrees to, and hereby does, assign to CR/PL its rights in the Ancillary Marks, which marks and corresponding registrations, if any, are set forth in Exhibit A hereof, together with the goodwill of the business represented thereby for use only in connection with the manufacture and sale of Plumbing Products.

2.3 Crane agrees to, and hereby does, assign, subject to Section 2.4 below, whatever trademark rights, including common law trademark rights, it has established anywhere in the world (except to the extent such assignment is separately made by Crane Canada in the APA with respect to Canada only) in the mark CRANE in connection with the manufacture and sale of Plumbing Products for use only in connection with the manufacture and sale of Plumbing Products and only in the form of the composite mark "Crane Plumbing," together with the goodwill of the business represented thereby.

2.4. The assignment set forth in Section 2.3 above is subject to the following limitations:

- i) Crane does not have, and does not represent that it has, established trademark rights in the mark "CRANE" or the composite mark "Crane Plumbing," for Plumbing Products in all countries and/or territories of the world, including in particular those outside the United States, and therefore this is an assignment of only existing trademark rights, if any, that are owned by Crane;
- ii) CR/PL may, at its own risk, cost and expense, seek to obtain registrations of trademark rights in the composite mark "Crane Plumbing" for use in connection with the manufacture and sale of Plumbing Products; CR/PL agrees that it shall not use, and shall not apply to register, the mark CRANE alone for any goods and services whatsoever; and
- iii) Crane's assignment of trademark rights as provided in Section 2.3 above is not an assignment of any trademark registrations, or any trademark rights arising from such registrations, Crane owns for the mark CRANE, or incorporating the mark CRANE, anywhere in the world, except those expressly provided for in Section 2.1 herein. With respect to any and all such registrations, Crane is obligated only to delete from the description of goods applicable to such registrations any reference to goods falling within the definition of Plumbing Products and to do so only when such registrations are renewed.

2.5. With regard to U.S. Registration No. 293,974, the parties agree that when Crane files its Section 8 declaration of use and Section 9 renewal application, the following Plumbing Products will be omitted from the description of goods contained in or referenced by the declaration and renewal application:

Faucets, bibbs, plumbing waste fixtures, flush valves, mixing valves, ball clocks, and other supply valves, all made of brass, cast iron, malleable iron, or other alloys; lavatory and sink traps made of earthenware, iron, or brass, bath tubs, showers, closets, urinals, lavatories, sinks, laundry wash trays, flush tanks; fountains and bathroom trimmings, namely, clothes hooks, shelves, towel bars, holders for

tumblers, and soap, all made of iron, brass, glass, marble, wood, or earthenware.

2.6. Crane's assignment of trademark rights as provided in this Article II, as well as any trademark rights in the mark CRANE assigned under the APA, is expressly subject to CR/PL's agreement, and CR/PL therefore agrees, to use such trademark rights only in connection with the manufacture and sale of Plumbing Products and only in the form of the composite mark "Crane Plumbing." Therefore, this Agreement does not convey, and CR/PL agrees that it has no right to use, and CR/PL agrees that it shall not use, the mark CRANE in connection with any activities other than the manufacture, promotion, and sale of Plumbing Products or in any form, alone or in connection with any other words, symbols, phrases, devices or designs of any kind, including in domain names, other than in the form of the composite mark "Crane Plumbing."

2.7. CR/PL further agrees that, in its exercise of the assigned trademark rights, it shall not at any time use, or apply to register, the trademark CRANE without having in direct association therewith the designation PLUMBING. Direct association shall mean that there is no character, word, symbol, logo, or other print separating CRANE from PLUMBING so that overall commercial impression is no longer that of a composite mark consisting of both words CRANE and PLUMBING. The foregoing, however, shall not preclude CR/PL from using the Bird Logo or other CR/PL marks with the Crane Plumbing composite mark, provided that in all such cases the overall commercial impression of a composite mark consisting of both CRANE and PLUMBING is maintained. Exhibit B to this Agreement contains examples of Crane Plumbing composite marks used in accordance with this Section 2.7.

2.8. The parties agree that the assignments made herein are not intended, and shall not be construed, to assign or convey from Crane to CR/PL any trademark rights, including but not limited to any trademark registrations, or any trademark rights arising solely from such registrations, in the mark CRANE alone or in combination with any other words, symbols, phrases, or designs, except as expressly set forth in this Article II. Crane shall retain the right to use the mark CRANE, alone or in combination with any other words, symbols, phrases, devices or designs, except in the form of the composite mark Crane Plumbing or any mark confusingly similar thereto, and Crane shall likewise retain the right to use such CRANE marks on or in connection with the manufacture, promotion and sale of all goods and services, including goods and services on which, or with which, it is not presently using the CRANE marks, except on or in connection with the manufacture and sale of Plumbing Products. Crane further agrees that it will not use a mark identical or confusingly similar to the Bird Logo in connection with products its or its related companies sell that are related to or used in connection with the Plumbing Products.

2.9. The parties acknowledge that irreparable harm will be suffered in the event either party uses the mark CRANE contrary to the limitations specified herein and that the other party shall be entitled, in addition to its other rights, to enforce the use limitations referred to by injunction or decree of specific performance from a court having proper jurisdiction. Any claims, counterclaims or alleged breach by the party seeking such injunctive relief shall not be a defense to any such injunctive action brought to obtain specific enforcement of this Agreement.

2.10. In addition, CR/PL agrees that it shall have no right to grant any sublicense to use any of the trademark rights granted herein except in strict



conformance with the limitations set forth in the Agreement with respect to the use thereof. The parties may assign their rights under this Agreement, providing that thirty (30) days advance written notice is given to the other party and the assignee agrees in writing to be bound by the terms of this Agreement.

### ARTICLE III

#### License Termination

3.1. As of the Effective Date, the License and the 1996 Settlement Agreement shall be considered terminated and this Agreement shall govern ownership, registration and use of the mark CRANE throughout the world as between the parties hereto.

### ARTICLE IV

#### Existing Trademark Disputes

4.1. Crane represents and warrants that it is the legal owner of and has good title in and to the registered marks and is the legal title owner of all common law marks assigned to CR/PL under this Agreement; to its knowledge as of the Effective Date, the assigned marks do not infringe any person's trademark, copyright, or other proprietary rights; and, to its knowledge as of the Effective Date, there are no pending or threatened trademark disputes, infringements or claims involving any of the marks assigned to CR/PL under this Agreement, except for oppositions to the application in the U.K. filed by Elon Ltd. to register CRANE for products that would encompass Plumbing Products (hereinafter the "UK Oppositions").

4.2. As of September 5, 2001, Elon Ltd. requested that, in light of the UK Oppositions, its application to register CRANE be withdrawn. Accordingly, the UK

Oppositions should be moot. In the event that the UK Oppositions are not moot, or do not become moot by the Effective Date, Crane agrees to keep the UK Oppositions pending for up to thirty (30) days after the Effective Date, and to cooperate with CR/PL and to execute such documents as may be appropriate, to enable CR/PL to assume the role of Crane and to otherwise pursue the UK Oppositions, at its own risk, cost and expense. Unless CR/PL takes appropriate steps to assume Crane's role in the UK Oppositions and to pursue same within thirty (30) days after the Effective Date, Crane reserves the right to withdraw from the UK Oppositions.

## ARTICLE V

### Trademark Co-Existence Provisions

5.1. The parties agree that neither will oppose use or registration, or seek to cancel any registration, of their respective marks, or rights in the mark CRANE, so long as their respective use of CRANE is within the scope of this Agreement.

5.2 The parties also agree to cooperate in the event any other party, including customers, regulatory and government agencies and/or registration authorities, seek confirmation that the parties' use of their respective marks, in accordance with the terms of this Agreement, is mutually acceptable and is not likely to lead to confusion. When necessary for a party to obtain a trademark registration, in accordance with the terms of this agreement, the other party agrees to provide that party with a written consent to registration of its trademark(s) that can be submitted to the relevant trademark office(s).

5.3. Should the need arise, the parties will cooperate to take all steps reasonably necessary to minimize the risk of confusion by customers from arising in the

future and to correct any misimpression that any customer may have about the companies and their marks.

5.4. The parties agree that the use of the trade name and trademark CRANE PLUMBING by CR/PL for Plumbing Products, on the one hand, and Crane's use of CRANE for all products other than Plumbing Products, on the other, is not likely to cause confusion, mistake, or deception because of, among other things, the fact that the products of Crane, on the one hand, and CR/PL, on the other, are very different, the customers for their products are sophisticated, and the trademarks as used are distinct from one another.

5.2. This Agreement shall not waive or prejudice the parties' rights to assert claims for breach of this Agreement or to enforce any and all trademark rights either owns against any third party, including claims for infringement, false and deceptive advertising, dilution, domain name rights and/or opposition and/or cancellation of claims in conflicting registrations or domain names.

## ARTICLE V

### Miscellaneous

6.1. This Agreement, when effective, is intended to be and is binding on and inures to the benefit of the parties, their agents, servants, employees, officers, directors, legal representatives, parents, subsidiaries, affiliates, successors and assigns, jointly and severally.

6.2. This Agreement may be executed in two or more counterparts, each of which shall be deemed an original but all of which together shall constitute one and the same Agreement.

6.3. All parties to this Agreement agree that the terms and conditions of this Agreement shall be maintained in confidence and that no party shall give publicity to the same. Moreover, the parties agree to execute such other documents reasonably necessary to carry out the intent of this Agreement.

6.4. This Agreement contains the entire understanding between the parties and there are no oral understandings or other agreements between the parties which have not been incorporated herein. No waiver, amendment, or modification of any term of this Agreement shall be effective unless made in a writing executed by the party against whom such a waiver, amendment, or modification is sought to be enforced. No failure or delay by either party in exercising any right, power, or remedy under this Agreement shall be deemed as a waiver of such right, power, or remedy, or as a waiver of any other term, condition or remedy.

6.5. This Agreement shall be construed in accordance with the laws of the State of Connecticut. The parties agree that jurisdiction and venue for any action brought to enforce the terms of this Agreement shall be in a court of general jurisdiction located within the United States.

6.6. This Agreement shall be considered as drafted jointly by all the parties, and no uncertainty or ambiguity found in the terms hereof shall be construed for or against any party based on an attribution of drafting to any party.

6.7. The parties agree to execute any and all additional documents which may be reasonably necessary to effectuate the terms of this Agreement, including for example simplified trademark assignments for recordation purposes.

6.8. To the extent any conflict between provisions of this Agreement and the APA, the provisions of the Agreement shall govern.

6.9. Any required notice hereunder shall be sent via facsimile, a reputable overnight courier service, postage pre-paid, or via U.S. Mail (confirmed by one of the first two methods) to the personal attention of the following representatives of the parties:

(i) representing Crane:

Augustus I. duPont  
Crane Co.  
100 First Stamford Place  
Stamford, CT 06902  
Fax: 203/363-7350

with copy to:

James R. Kyper, Esquire  
Kirkpatrick & Lockhart LLP  
Henry W. Oliver Building  
535 Smithfield Street  
Pittsburgh, PA 15222  
Fax: 412/355-6501

(ii) representing CR/PL:

Reed Beidler  
CR/PL, L.L.C.  
1235 Hartry Avenue  
Evanston, IL 60606  
Fax: 847/864-7600

with copy to:

Paula Jill Krasny, Esquire  
Baker & McKenzie  
One Prudential Plaza  
130 East Randolph Drive  
Chicago, IL 60601  
Fax: 312/861-2899

IN WITNESS WHEREOF, the parties have executed this Agreement as of the Effective Date set forth above.

ATTEST:

CR/PL, L.P.

\_\_\_\_\_

By: Barry L. Brown

ATTEST:

Crane Co.

\_\_\_\_\_

By: Augustin I. Dupont  
VICE PRESIDENT

This Agreement is also executed by the following parties, each of whom join in and agree to be bound to the undertakings and terms being made herein to the extent required to carry out the intent of this Agreement

ATTEST:

Crane Canada Inc.

\_\_\_\_\_

By: [Signature]

ATTEST:

Fiat Products, LTD.

\_\_\_\_\_

By: Barry L. Brown

EXHIBIT A  
ANCILLARY MARKS

REGISTERED

<u>REGISTRATION NO.</u>	<u>TRADEMARK</u>
418,948	ALLIANCEWARE
1,203,485	CITADEL
701,644	COUNTRY CLUB
374,242	CRITERION
848,862	DIAL-ESE
1,137,808	EMBASSY & DESIGN
1,139,443	GALAXY PLUMBING PRODUCTS
1,129,203	HUSHPAD
439,111	MAGICLOSE
904,583	RIVIERA
998,950	SCULPTRA
886,991	UNETTE

UNREGISTERED TRADEMARKS

ANTIGUA  
DALTON  
EMPRESS  
FIRENZA  
GRAN PRIX  
NIRVANA  
TAHITI

EXHIBIT B

A:\cr-pl-10-01-01.doc



EVERYWHERE YOU LOOK

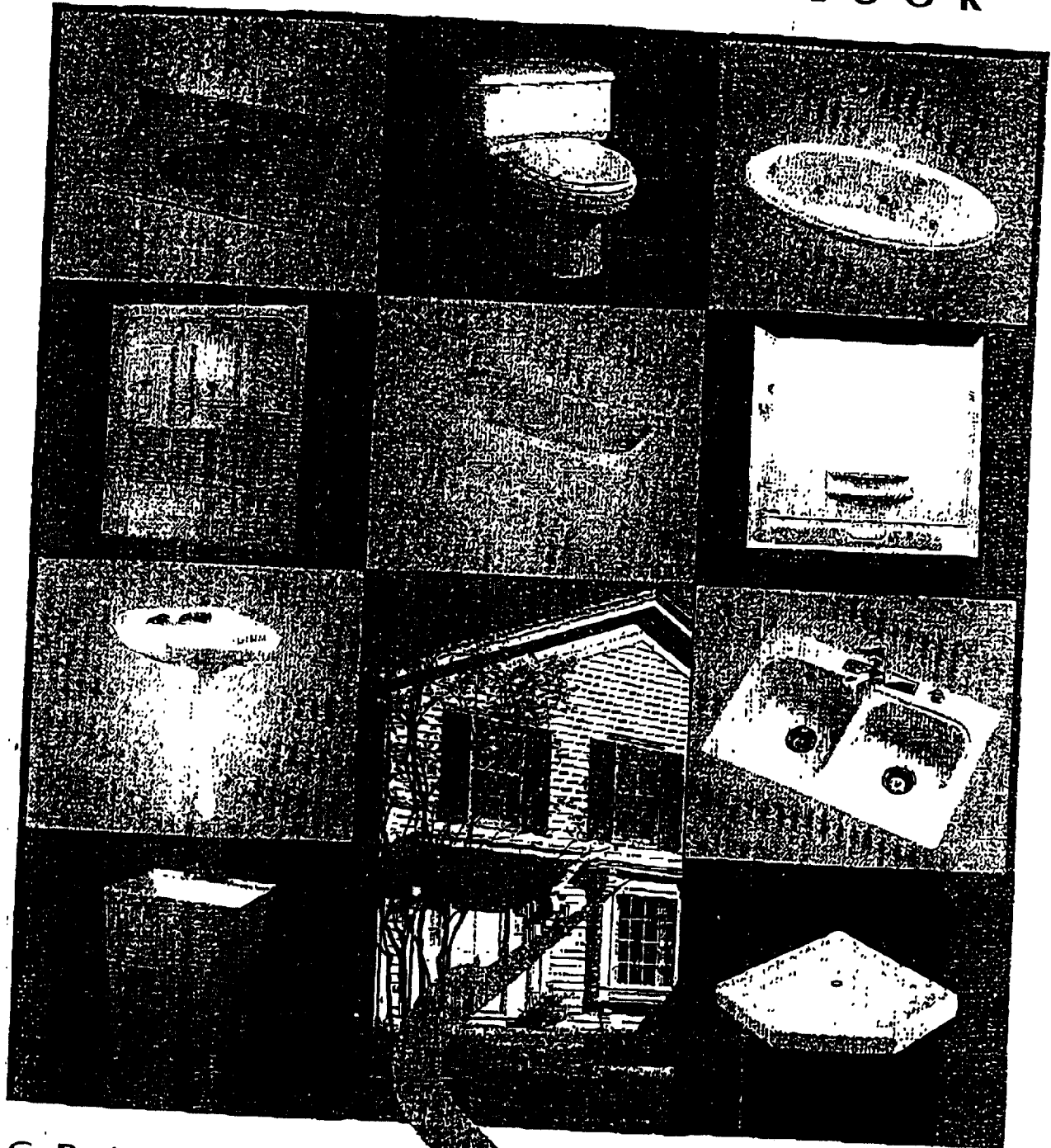

CRANE PLUMBING IS THERE  
HOUSE • CONDOMINIUM • APARTMENT • TOWNHOUSE

CRANE PLUMBING

FIAT PRODUCTS

1235 HARTREY

• 847-864-9777

Sanymetal

TRADEMARK

REEL: 002646 FRAME: 0073

EVERYWHERE YOU LOOK

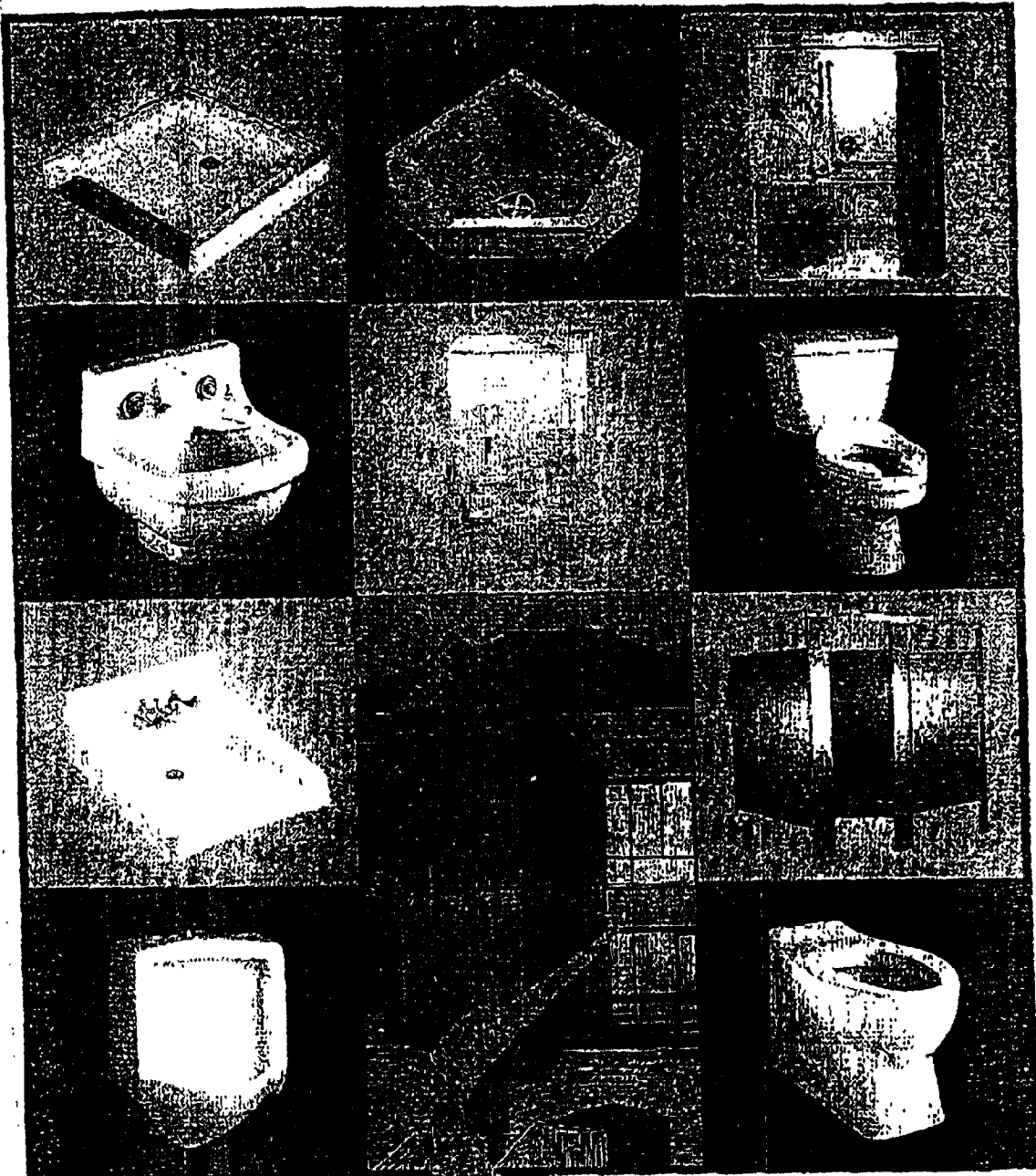

CRANE PLUMBING IS THERE  
HEALTHCARE • EDUCATION • COMMERCIAL • STADIUM • GOVERNMENT

CRANE PLUMBING

FIAT PRODUCTS

1235 HARTREY

• 847-864-9777

Sanymetal

TRADEMARK  
REEL: 002646 FRAME: 0074



FIAT PRODUCTS\* • Sanymetal • Universal-Rundle • Showerite

CR/PL, L.L.C.  
1235 Hartrey Avenue  
Evanston, IL 60202  
Tel 847/864-7600  
Fax 847/864-7652

CRANE PLUMBING® LOGO SHEET

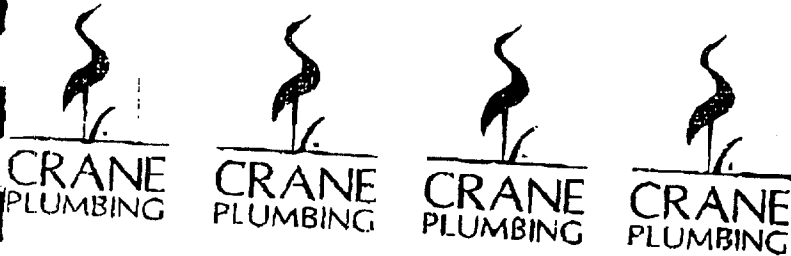
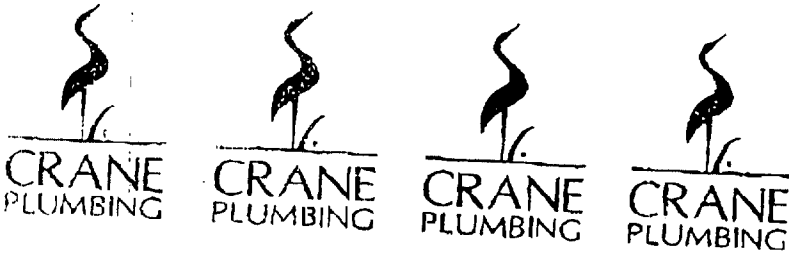
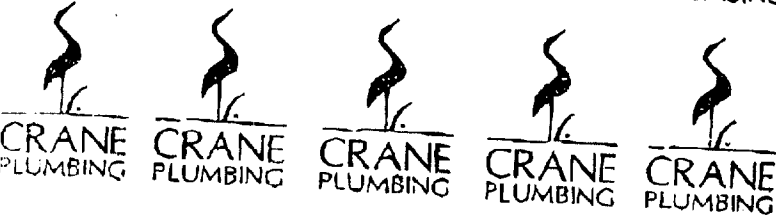
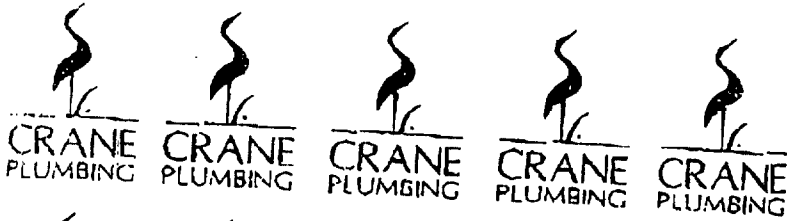



# Showerte®

A CRANE PLUMBING COMPANY



# Showerte®

A CRANE PLUMBING COMPANY



# Showerte®

A CRANE PLUMBING COMPANY



# Showerte®

A CRANE PLUMBING COMPANY



# Showerte®

A CRANE PLUMBING COMPANY



# Showerte®

A CRANE PLUMBING COMPANY



# Showerte®

A CRANE PLUMBING COMPANY



# Showerte®

A CRANE PLUMBING COMPANY



# Showerte®

A CRANE PLUMBING COMPANY



# Showerte®

A CRANE PLUMBING COMPANY



# Showerte®

A CRANE PLUMBING COMPANY



# Showerte®

A CRANE PLUMBING COMPANY



# Showerte®

A CRANE PLUMBING COMPANY



# Showerte®

A CRANE PLUMBING COMPANY



**Universal-Rundle**  
A CRANE PLUMBING COMPANY



**Universal-Rundle**  
A CRANE PLUMBING COMPANY



**Universal-Rundle**  
A CRANE PLUMBING COMPANY



**Universal-Rundle**  
A CRANE PLUMBING COMPANY



**Universal-Rundle**  
A CRANE PLUMBING COMPANY



**Universal-Rundle**  
A CRANE PLUMBING COMPANY



**Universal-Rundle**  
A CRANE PLUMBING COMPANY



**Universal-Rundle**  
A CRANE PLUMBING COMPANY



**Universal-Rundle**  
A CRANE PLUMBING COMPANY



**Universal-Rundle**  
A CRANE PLUMBING COMPANY



**Universal-Rundle**  
A CRANE PLUMBING COMPANY



**Universal-Rundle**  
A CRANE PLUMBING COMPANY



**Universal-Rundle**  
A CRANE PLUMBING COMPANY



**Universal-Rundle**  
A CRANE PLUMBING COMPANY



# Sanymetal®

A CRANE PLUMBING COMPANY



# Sanymetal®

A CRANE PLUMBING COMPANY



# Sanymetal®

A CRANE PLUMBING COMPANY



# Sanymetal®

A CRANE PLUMBING COMPANY



# Sanymetal®

A CRANE PLUMBING COMPANY



# Sanymetal®

A CRANE PLUMBING COMPANY



# Sanymetal®

A CRANE PLUMBING COMPANY



# Sanymetal®

A CRANE PLUMBING COMPANY



# Sanymetal®

A CRANE PLUMBING COMPANY



# Sanymetal®

A CRANE PLUMBING COMPANY



# Sanymetal®

A CRANE PLUMBING COMPANY



# Sanymetal®

A CRANE PLUMBING COMPANY



# Sanymetal®

A CRANE PLUMBING COMPANY

# CRANE PLUMBING

KITCHEN AND BATHROOM FIXTURES

TRADEMARK

REEL: 002646 FRAME: 0080



CRANE  
PLUMBING

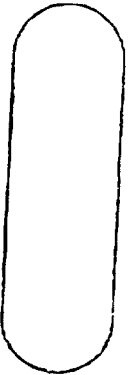

**HYMONT, JR<sup>TM</sup>**

**3815**

**1.6 GPF / 6.0 LPF  
ELONGATED RIM**

**16 1/8" HIGH**



**ADA COMPLIANT**

FOR 10" ROUGH-IN USE  
WITH 3-7/40 TANK

FOR 12" ROUGH-IN USE WITH  
3-5/4E, 3-5/4BE TANKS



HANDLE WITH CARE

SHIPPING LABEL TO BE PLACED ON THE TOP  
FLAP OF THE CARTON

**ATTENTION**

CRANE PLUMBING PRODUCTS ARE PACKAGED TO CONFORM WITH ALL THE PACKAGING RULES AND REGULATIONS OF THE NATIONAL MOTOR FREIGHT CLASSIFICATION. OUR UNITS ARE PACKAGED TO WITHSTAND THE HAZARDS OF NORMAL TRANSPORTATION HANDLING. IF THE CARTON IS DAMAGED, OR DAMAGE TO THE CONTENTS IS SUSPECTED YOU MUST INDICATE THE DAMAGE ON THE DELIVERY RECEIPT IN ORDER TO SUBSTANTIATE A CLAIM AGAINST THE CARRIER. FILE A CLAIM WITH THE CARRIER IMMEDIATELY.

**LOW-CONSUMPTION CLOSET**

THIS FIXTURE COMPLIES WITH ASME A112.19.2M AND QUALIFIES ACCORDING TO ASME A112.19.6M TEST PROCEDURES AS A LOW-CONSUMPTION WATERCLOSET WITH AN AVERAGE CONSUMPTION PER FLUSH OF 1.6 GALLONS OR LESS.

**WARNING:**

THIS UNIT HAS BEEN WATER AND FLUSH TESTED. DO NOT STORE AT TEMPERATURES BELOW 32° FAHRENHEIT.



VITREOUS CHINA PLUMBING FIXTURE

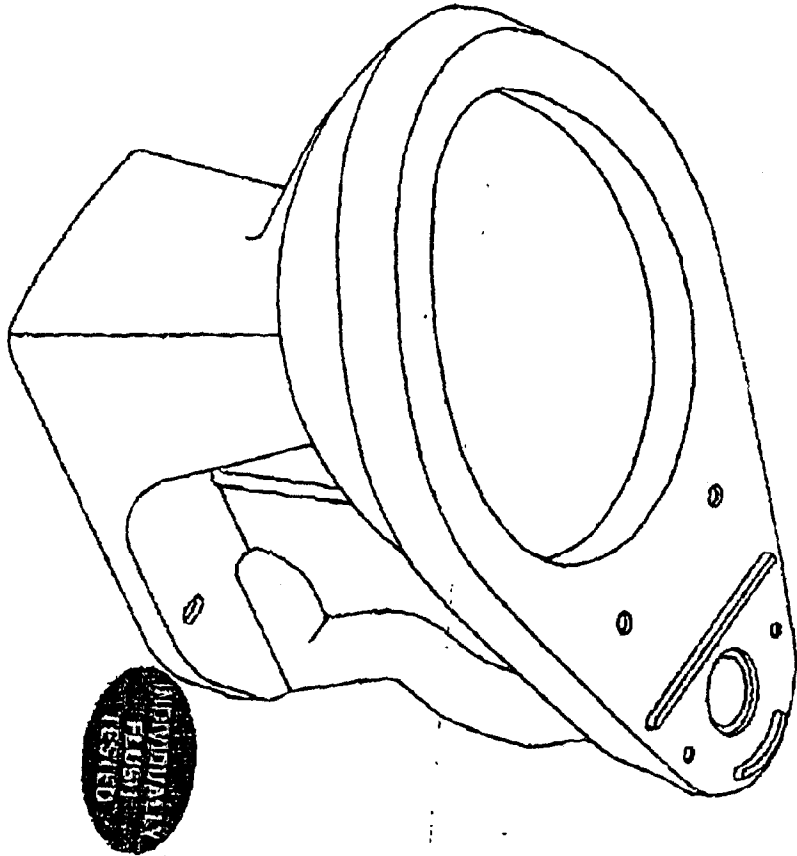

**HYMONT, JR™**  
 1.6 GPF / 6.0 LPF  
 ELONGATED RIM - 16 1/8" HIGH



ADA COMPLIANT

HANDLE WITH CARE

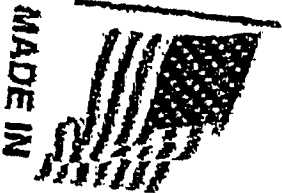

TRADEMARK

REEL: 002646 FRAME: 0082

RECORDED: 01/08/2003