

TRADEMARK ASSIGNMENT

Electronic Version v1.1
 Stylesheet Version v1.1

SUBMISSION TYPE:	NEW ASSIGNMENT
NATURE OF CONVEYANCE:	SECURITY INTEREST

CONVEYING PARTY DATA

Name	Formerly	Execution Date	Entity Type
OTTLITE TECHNOLOGIES, INC.		02/04/2013	CORPORATION: DELAWARE

RECEIVING PARTY DATA

Name:	MARQUETTE BUSINESS CREDIT, INC.
Street Address:	333 S. Grand Ave., Suite 2350
Internal Address:	Attn: Portfolio Manager
City:	Los Angeles
State/Country:	CALIFORNIA
Postal Code:	90071
Entity Type:	CORPORATION: MINNESOTA

PROPERTY NUMBERS Total: 22

Property Type	Number	Word Mark
Registration Number:	3351249	IT'S LIKE NATURAL DAYLIGHT INDOORS
Registration Number:	2421453	THE LEARNING LIGHT
Registration Number:	3756660	CREATIVE HD
Registration Number:	3201104	EASYVIEW
Registration Number:	3693600	ENJOY LIFE IN HD
Registration Number:	3454477	MULTI-FLEX CRAFT FLOOR LAMP
Registration Number:	3786392	OFFICE HD
Registration Number:	4013561	FLAWLESS ABSOLUTELY FLAWLESS
Registration Number:	1704198	OTT-LITE
Registration Number:	3693599	OTTLITE ENJOY LIFE IN HD
Registration Number:	4007785	508
Registration Number:	3693602	OTTLITE ENJOY LIFE IN HD.
Registration Number:	3766783	OTTLITE

CH \$565.00 3351249

Registration Number:	3413355	OTT-LITE HIGH DEFINITION NATURAL LIGHTIN
Registration Number:	3593323	HIGH DEFINITION LIGHTING
Registration Number:	2573318	OTT-LITE TECHNOLOGY
Registration Number:	2592054	OTT-LITE VISION SAVER
Registration Number:	3756659	READER'S HD
Registration Number:	3267759	SEEING IS BELIEVING
Registration Number:	3402715	TOTAL FLEX
Registration Number:	3408939	BRING THE POWER OF NATURAL DAYLIGHT INDO
Serial Number:	85762445	SEE DETAILS CLEARLY AND COLORS ACCURATEL

CORRESPONDENCE DATA

Fax Number: 2134432926
Correspondence will be sent to the e-mail address first; if that is unsuccessful, it will be sent via US Mail.
Phone: 213-617-5493
Email: jcravitz@sheppardmullin.com
Correspondent Name: Sheppard, Mullin, Richter & Hampton LLP
Address Line 1: 333 S. Hope St., 48th Floor
Address Line 2: Attn: J. Cravitz
Address Line 4: Los Angeles, CALIFORNIA 90071

ATTORNEY DOCKET NUMBER:	13EB-175122
NAME OF SUBMITTER:	Julie Cravitz
Signature:	/julie cravitz/
Date:	07/09/2013

Total Attachments: 26
source=OttLite Technologies - IPSA#page1.tif
source=OttLite Technologies - IPSA#page2.tif
source=OttLite Technologies - IPSA#page3.tif
source=OttLite Technologies - IPSA#page4.tif
source=OttLite Technologies - IPSA#page5.tif
source=OttLite Technologies - IPSA#page6.tif
source=OttLite Technologies - IPSA#page7.tif
source=OttLite Technologies - IPSA#page8.tif
source=OttLite Technologies - IPSA#page9.tif
source=OttLite Technologies - IPSA#page10.tif
source=OttLite Technologies - IPSA#page11.tif
source=OttLite Technologies - IPSA#page12.tif
source=OttLite Technologies - IPSA#page13.tif
source=OttLite Technologies - IPSA#page14.tif
source=OttLite Technologies - IPSA#page15.tif
source=OttLite Technologies - IPSA#page16.tif
source=OttLite Technologies - IPSA#page17.tif

source=OttLite Technologies - IPSA#page18.tif
source=OttLite Technologies - IPSA#page19.tif
source=OttLite Technologies - IPSA#page20.tif
source=OttLite Technologies - IPSA#page21.tif
source=OttLite Technologies - IPSA#page22.tif
source=OttLite Technologies - IPSA#page23.tif
source=OttLite Technologies - IPSA#page24.tif
source=OttLite Technologies - IPSA#page25.tif
source=OttLite Technologies - IPSA#page26.tif

INTELLECTUAL PROPERTY SECURITY AGREEMENT

This INTELLECTUAL PROPERTY SECURITY AGREEMENT (the "Agreement") is made as of February 4, 2013, by and between OTTLITE TECHNOLOGIES, INC., a Delaware corporation ("Grantor"), and MARQUETTE BUSINESS CREDIT, INC., a Minnesota corporation with its chief executive office and principal place of business located in Dallas County, Texas ("Secured Party"), with reference to the following facts:

RECITALS

A. Grantor and Secured Party are parties to that certain Loan and Security Agreement, of even date herewith (as it has been or may be renewed, extended, amended, supplemented, restated or otherwise modified from time to time, the "Loan Agreement"), pursuant to which the Secured Party has provided certain credit facilities to Grantor. Capitalized terms used but not otherwise defined herein shall have the meaning set forth in the Loan Agreement.

B. In order to induce Secured Party to provide such financing to Grantor, in addition to the other Loan Documents, Grantor is willing to enter into this Agreement with Secured Party to secure the Obligations.

NOW, THEREFORE, THE PARTIES HERETO AGREE AS FOLLOWS:

1. Grant of Security Interest. As collateral security for the prompt and complete payment and performance of the Obligations, Grantor hereby grants a security interest and mortgage to Secured Party, as security, in and to Grantor's entire right, title and interest in, to and under all of its intellectual property, including without limitation the following (all of which shall collectively be called the "Collateral"):

(a) Any and all copyright rights, copyright applications, copyright registrations and like protections in each work or authorship and derivative work thereof, whether published or unpublished and whether or not the same also constitutes a trade secret, now or hereafter existing, created, acquired or held, including without limitation those set forth on Exhibit A attached hereto (collectively, the "Copyrights");

(b) Any and all trade secrets, and any and all intellectual property rights in computer software and computer software products now or hereafter existing, created, acquired or held;

(c) Any and all design rights which may be available to Grantor now or hereafter existing, created, acquired or held;

(d) All patents, patent applications and like protections including without limitation improvements, divisions, continuations, renewals, reissues, extensions and continuations in part of the same, including without limitation the patents and patent applications set forth on Exhibit B attached hereto (collectively, the "Patents");

(e) Any trademark and servicemark rights, whether registered or not, applications to register and registrations of the same and like protections, and the entire goodwill of the business of Grantor connected with and symbolized by such trademarks, including without limitation those set forth on Exhibit C attached hereto (collectively, the "Trademarks");

(f) Any and all claims for damages by way of past, present and future infringement of any of the rights included above, with the right, but not the obligation, to sue for and collect such damages for said use or infringement of the intellectual property rights identified above;

(g) All licenses or other rights to use any of the Copyrights, Patents or Trademarks, and all license fees and royalties arising from such use to the extent permitted by such license or rights;

(h) All amendments, renewals and extensions of any of the Copyrights, Trademarks or Patents; and

(i) All proceeds and products of the foregoing, including without limitation all payments under insurance or any indemnity or warranty payable in respect of any of the foregoing.

Anything contained herein to the contrary notwithstanding, "Collateral" shall not be deemed to include Excluded Equity.

2. Covenants and Warranties. Grantor represents, warrants, covenants and agrees as follows:

(a) Grantor is now the sole owner of the Collateral, except for licenses granted by Grantor to its customers in the ordinary course of business;

(b) Except as set forth in the Schedule, Grantor's rights as a licensee of intellectual property do not give rise to more than ten percent (10%) of its gross revenue in any given month, including without limitation revenue derived from the sale, licensing, rendering or disposition of any product or service;

(c) Performance of this Agreement does not conflict with or result in a breach of any agreement to which Grantor is party or by which Grantor is bound;

(d) During the term of this Agreement, Grantor will not transfer or otherwise encumber any interest in the Collateral, except for licenses granted by Grantor in the ordinary course of business, as set forth in this Agreement, Permitted Liens and as otherwise may be permitted under the Loan Agreement;

(e) To its knowledge, each of the Patents is valid and enforceable, and no part of the Collateral has been judged invalid or unenforceable, in whole or in part, and no claim has been made that any part of the Collateral violates the rights of any third party;

(f) Grantor shall deliver to Secured Party within thirty (30) days of the last day of each fiscal quarter, a report signed by Grantor, in form reasonably acceptable to Secured Party, listing any applications or registrations that Grantor has made or filed in respect of any patents, copyrights or trademarks during such prior fiscal quarter, if any, and the status of any outstanding applications or registrations if such status has changed since the last such delivery by Grantor to Secured Party. Grantor shall promptly advise Secured Party of any material change in the composition of the Collateral, including but not limited to any subsequent ownership right of the Grantor in or to any Trademark, Patent or Copyright not specified in this Agreement;

(g) Grantor shall (i) protect, defend and maintain the validity and enforceability of the Trademarks, Patents and Copyrights (ii) use its best efforts to detect infringements of the Trademarks, Patents and Copyrights and promptly advise Secured Party in writing of material infringements detected

and (iii) not allow any Trademarks, Patents or Copyrights to be abandoned, forfeited or dedicated to the public without the written consent of Secured Party, which shall not be unreasonably withheld;

(h) Grantor shall register or cause to be registered (to the extent not already registered) with the United States Patent and Trademark Office or the United States Copyright Office, as the case may be, those registerable intellectual property rights now owned or hereafter developed or acquired by Grantor to the extent that Grantor, in its reasonable business judgment, deems it appropriate to so protect such intellectual property rights;

(i) Grantor shall promptly give Secured Party written notice of any applications or registrations of intellectual property rights filed with the United States Patent and Trademark Office, including the date of such filing and the registration or application numbers, if any. Grantor shall (i) give Secured Party not less than 30 days prior written notice of the filing of any applications or registrations with the United States Copyright Office, including the title of such intellectual property rights to be registered, as such title will appear on such applications or registrations, and the date such applications or registrations will be filed, and (ii) prior to the filing of any such applications or registrations, shall execute such documents as Secured Party may reasonably request for Secured Party to maintain its perfection in such intellectual property rights to be registered by Grantor, and upon the request of Secured Party, shall file such documents simultaneously with the filing of any such applications or registrations. Upon filing any such applications or registrations with the United States Copyright Office, Grantor shall promptly provide Secured Party with (i) a copy of such applications or registrations, without the exhibits, if any, thereto, (ii) evidence of the filing of any documents requested by Secured Party to be filed for Secured Party to maintain the perfection and priority of its security interest in such intellectual property rights, and (iii) the date of such filing;

(j) Secured Party may audit the Collateral to confirm compliance with this Section, provided such audit may not occur more often than twice per year, unless an Event of Default has occurred and is continuing;

(k) This Agreement creates, and in the case of after acquired Collateral, this Agreement will create at the time Grantor first has rights in such after acquired Collateral, in favor of Secured Party a valid and perfected first priority security interest in the Collateral in the United States securing the payment and performance of the Obligations;

(l) All information heretofore, herein or hereafter supplied to Secured Party by or on behalf of Grantor with respect to the Collateral is accurate and complete in all material respects;

(m) Grantor shall not enter into any agreement that would materially impair or conflict with Grantor's obligations hereunder without Secured Party's prior written consent, which consent shall not be unreasonably withheld. Grantor shall not permit the inclusion in any material contract to which it becomes a party of any provisions that could or might in any way prevent the creation of a security interest in Grantor's rights and interests in any property included within the definition of the Collateral acquired under such contracts; and

(n) Upon any Responsible Officer of Grantor obtaining actual knowledge thereof, Grantor will promptly notify Secured Party in writing of any event that materially adversely affects the value of any Collateral, the ability of Grantor to dispose of any Collateral or the rights and remedies of Secured Party in relation thereto, including the levy of any legal process against any of the Collateral.

3. Secured Party's Rights. Secured Party shall have the right, but not the obligation, to take, at Grantor's sole expense, any actions that Grantor is required under this Agreement to take but which

Grantor fails to take, after fifteen (15) days written notice to Grantor. Grantor shall reimburse and indemnify Secured Party for all reasonable costs and reasonable expenses incurred in the reasonable exercise of its rights under this Section 3.

4. Reserved.

5. Further Assurances; Attorney in Fact.

(a) On a continuing basis, Grantor will make, execute, acknowledge and deliver, and file and record in the proper filing and recording places in the United States, all such instruments, including appropriate financing and continuation statements and collateral agreements and filings with the United States Patent and Trademark Office and the Register of Copyrights, and take all such action as may reasonably be deemed necessary or advisable, or as reasonably requested by Secured Party, to perfect Secured Party's security interest in all Copyrights, Patents and Trademarks and otherwise to carry out the intent and purposes of this Agreement, or for assuring and confirming to Secured Party the grant or perfection of a security interest in all Collateral.

(b) Grantor hereby irrevocably appoints Secured Party as Grantor's attorney in fact, with full authority in the place and stead of Grantor and in the name of Grantor, from time to time in Secured Party's discretion, to take any action and to execute any instrument which Secured Party may deem necessary or advisable to accomplish the purposes of this Agreement, including (i) to modify, in its sole discretion, this Agreement without first obtaining Grantor's approval of or signature to such modification by amending Exhibit A, Exhibit B and Exhibit C, hereof, as appropriate, to include reference to any right, title or interest in any Copyrights, Patents or Trademarks acquired by Grantor after the execution hereof or to delete any reference to any right, title or interest in any Copyrights, Patents or Trademarks in which Grantor no longer has or claims any right, title or interest, (ii) to file, in its sole discretion, one or more financing or continuation statements and amendments thereto, relative to any of the Collateral without the signature of Grantor where permitted by law and (iii) after the occurrence of an Event of Default, to transfer the Collateral into the name of Secured Party or a third party to the extent permitted under the Texas Uniform Commercial Code.

6. Events of Default. The occurrence of any of the following shall constitute an Event of Default under this Agreement:

(a) An Event of Default occurs under the Loan Agreement; or

(b) Grantor breaches any warranty, covenant or agreement made by Grantor in this Agreement.

7. Remedies. Upon the occurrence and during the continuance of an Event of Default, Secured Party shall have the right to exercise all the remedies of a secured party under the Texas Uniform Commercial Code, including without limitation the right to require Grantor to assemble the Collateral and any tangible property in which Secured Party has a security interest and to make it available to Secured Party at a place designated by Secured Party. Secured Party shall have a nonexclusive, royalty free license to use the Copyrights, Patents and Trademarks to the extent reasonably necessary to permit Secured Party to exercise its rights and remedies upon the occurrence and during the continuance of an Event of Default. Grantor will pay any expenses (including reasonable attorneys' fees) incurred by Secured Party in connection with the exercise of any of Secured Party's rights hereunder, including without limitation any expense incurred in disposing of the Collateral. All of Secured Party's rights and remedies with respect to the Collateral shall be cumulative.

8. Indemnity. Grantor agrees to defend, indemnify and hold harmless Secured Party and its officers, employees, and agents against: (a) all obligations, demands, claims, and liabilities claimed or asserted by any other party in connection with the transactions contemplated by this Agreement, and (b) all losses or expenses in any way suffered, incurred, or paid by Secured Party as a result of or in any way arising out of, following or consequential to transactions between Secured Party and Grantor, whether under this Agreement or under any other Loan Document (including without limitation reasonable attorneys' fees and reasonable expenses), except for losses arising from or out of Secured Party's gross negligence or willful misconduct.

9. Course of Dealing. No course of dealing, nor any failure to exercise, nor any delay in exercising any right, power or privilege hereunder shall operate as a waiver thereof.

10. Attorneys' Fees. If any action relating to this Agreement is brought by either party hereto against the other party, the prevailing party shall be entitled to recover reasonable attorneys' fees, costs and disbursements.

11. Amendments. This Agreement may be amended only by a written instrument signed by both parties hereto.

12. Counterparts. This Agreement may be executed in two or more counterparts, each of which shall be deemed an original but all of which together shall constitute the same instrument.

13. Governing Law; Venue.

(a) THIS AGREEMENT, THE INTERPRETATION AND CONSTRUCTION OF THIS AGREEMENT AND OF ANY PROVISION OF THIS AGREEMENT AND OF ANY ISSUE RELATING TO THE TRANSACTIONS CONTEMPLATED BY THIS AGREEMENT SHALL BE GOVERNED BY THE LAWS OF THE STATE OF TEXAS NOT INCLUDING CONFLICTS OF LAWS RULES.

(b) ANY LEGAL ACTION OR PROCEEDING WITH RESPECT TO THIS AGREEMENT OR ANY OTHER LOAN DOCUMENT MAY BE BROUGHT IN THE COURTS OF THE STATE OF CALIFORNIA OR OF THE UNITED STATES OF AMERICA FOR THE CENTRAL DISTRICT OF CALIFORNIA, OR IN THE COURTS OF THE STATE OF TEXAS OR OF THE UNITED STATES OF AMERICA FOR THE NORTHERN DISTRICT OF TEXAS, AND BY EXECUTION AND DELIVERY OF THIS AGREEMENT, EACH OF GRANTOR AND SECURED PARTY CONSENTS TO THE NON-EXCLUSIVE JURISDICTION OF THOSE COURTS. EACH OF GRANTOR AND SECURED PARTY IRREVOCABLY WAIVES ANY OBJECTION, INCLUDING ANY OBJECTION TO VENUE ON THE GROUNDS OF FORUM NON CONVENIENS, WHICH IT MAY NOW OR HEREAFTER HAVE TO THE BRINGING OF ANY SUCH ACTION OR PROCEEDING IN SUCH JURISDICTION. NOTWITHSTANDING THE FOREGOING, SECURED PARTY SHALL HAVE THE RIGHT TO BRING ANY ACTION OR PROCEEDING AGAINST GRANTOR OR ITS PROPERTY IN THE COURTS OF ANY OTHER JURISDICTION SECURED PARTY DEEMS NECESSARY OR APPROPRIATE IN ORDER TO EXERCISE REMEDIES WITH RESPECT TO THE COLLATERAL.

14. Payment and Performance. All required payments on the Obligations shall be made to Marquette, at Marquette's chief executive office in Dallas, Dallas County, Texas.

IN WITNESS WHEREOF, the parties hereto have executed this Agreement on the day and year first above written.

GRANTOR:

OTTLITE TECHNOLOGIES, INC.,
a Delaware corporation

By: 
Name: Thomas H. Beyer
Title: Chief Executive Officer

SECURED PARTY:

MARQUETTE BUSINESS CREDIT, INC.,
a Minnesota corporation

By: _____
Name: John D. Watkins
Title: Vice President

IN WITNESS WHEREOF, the parties hereto have executed this Agreement on the day and year first above written.

GRANTOR:

OTTLITE TECHNOLOGIES, INC.,
a Delaware corporation

By: _____
Name: Thomas H. Beyer
Title: Chief Executive Officer

SECURED PARTY:

MARQUETTE BUSINESS CREDIT, INC.,
a Minnesota corporation

By:  _____
Name: John D. Watkins
Title: Vice President

EXHIBIT A

Copyrights

None.

EXHIBIT B

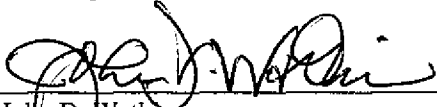
Patents

[See attached]

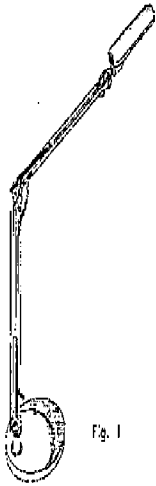
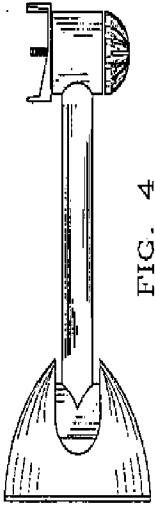

OTT-LITE PATENTS

Design Patents

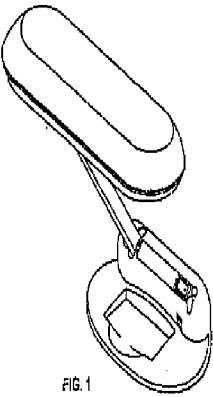
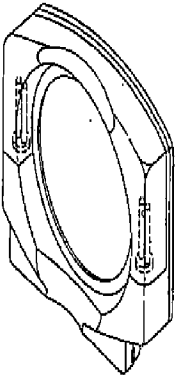
<u>F&B Ref. No.</u>	<u>Title</u>	<u>Country</u>	<u>Patent Number</u>	<u>Patent Date</u>
58014.79.1 	Desk Lamp	U.S.	D441,476	May 1, 2001 (term expires May 1, 2015)
58014.125.1 	Wall Bracket	U.S.	D488,705	April 20, 2004 (term expires April 20, 2018)

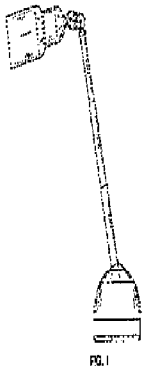
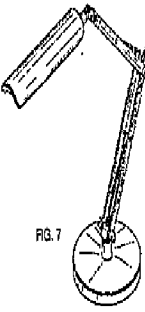
<u>F&B Ref. No.</u>	<u>Title</u>	<u>Country</u>	<u>Patent Number</u>	<u>Patent Date</u>
58014.126.1 	Lamp With Stand	U.S.	D507,841	July 26, 2005 (term expires July 26, 2019)
58014.127.1 	Mirror with Lamp	U.S.	D518,652	April 11, 2006 (term expires April 11, 2020)

<u>F&B Ref. No.</u>	<u>Title</u>	<u>Country</u>	<u>Patent Number</u>	<u>Patent Date</u>
58014.116.1  FIG. 1	Telescope Lamp	U.S.	D600,843	Sept. 22, 2009 (term expires Sept. 22, 2023)
58014.114.1  FIG. 7	Crane Lamp	U.S.	D600,844	Sept. 22, 2009 (term expires Sept. 22, 2023)

<u>F&B Ref. No.</u>	<u>Title</u>	<u>Country</u>	<u>Patent Number</u>	<u>Patent Date</u>
58014.115.1 	Desk Lamp	U.S.	D600,845	Sept. 22, 2009 (term expires Sept. 22, 2023)
58014.117.1 	Task Lamp	U.S.	D601,288	Sept. 29, 2009 (term expires Sept. 29, 2023)

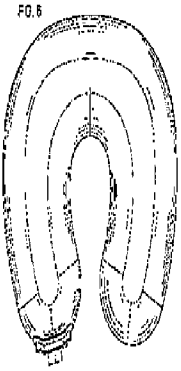
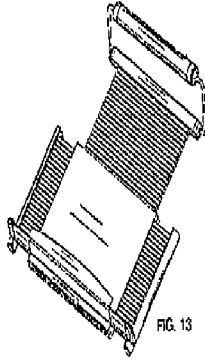

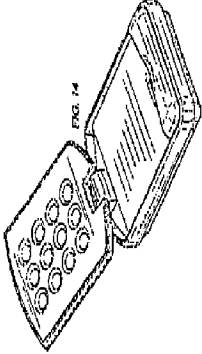
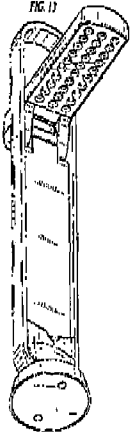
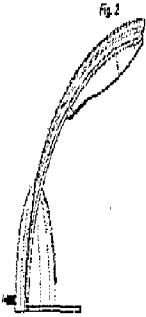
<u>F&B Ref. No.</u>	<u>Title</u>	<u>Country</u>	<u>Patent Number</u>	<u>Patent Date</u>
58014.118.1 	Pillow Lamp	U.S.	D604,438	Nov. 17, 2009 (term expires Nov. 17, 2023)
58014.128.1 	Book Light	U.S.	D611,633	March 9, 2010 (term expires March 9, 2024)

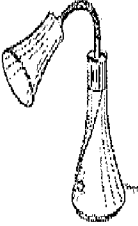
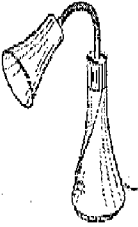
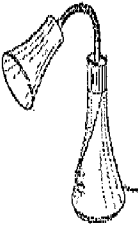
<u>F&B Ref. No.</u>	<u>Title</u>	<u>Country</u>	<u>Patent Number</u>	<u>Patent Date</u>
58014.119.1 	Pocket Light	U.S.	D614,334	April 20, 2010 (term expires April 20, 2024)
58014.120.1 	LED Task Light	U.S.	D615,681	May 11, 2010 (term expires May 11, 2024)
58014.106.2 	Lamp Assembly	U.S.	D652,981	Jan. 24, 2012 (term expires Jan. 24, 2026)

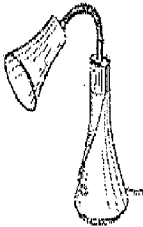
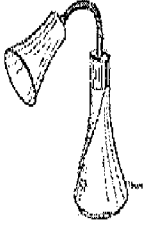
<u>F&B Ref. No.</u>	<u>Title</u>	<u>Country</u>	<u>Patent Number</u>	<u>Patent Date</u>
58014.113.2  FIG. 10	Convertible Table Lamp	U.S.	D640,403	June 21, 2011 (term expires June 21, 2025)
58014.113.3  FIG. 10	Convertible Table Lamp	EU	18148980001	Feb. 2, 2011 (term expires Feb. 2, 2036 presuming Renewals are filed)
58014.113.4  FIG. 10	Convertible Table Lamp	Australia	335271	Feb. 25, 2011 (term expires Feb. 4, 2021 presuming Renewals are filed)

<u>F&B Ref. No.</u>	<u>Title</u>	<u>Country</u>	<u>Patent Number</u>	<u>Patent Date</u>
58014.113.5  FIG. 10	Convertible Table Lamp	Mexico	35710	February 27, 2012 (term expires Feb. 4, 2026)
58014.113.8  FIG. 10	Convertible Table Lamp	China	201130022102.0	October 26, 2011 (term expires Feb. 9, 2021)

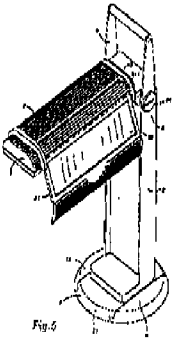
Utility Patents

<u>F&B Ref. No.</u>	<u>Title</u>	<u>Country</u>	<u>Patent Number</u>	<u>Patent Date</u>
58014.76.1 	Stretchable and Contractible Desk Lamp Device	U.S.	5,871,274	February 16, 1999 (term expires July 11, 2017)
58014.129.1 	Pivot Connector for Easel Lamp	U.S.	6,079,857	June 27, 2000 (term expires Jan. 25, 2019 with payment of maintenance fees)

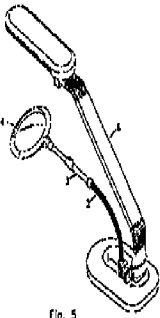
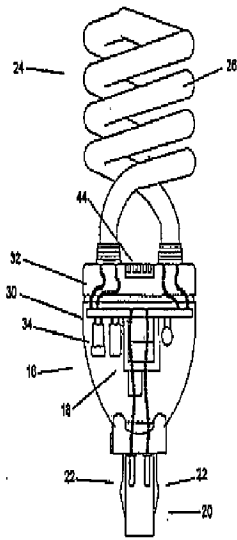
<u>F&B Ref. No.</u>	<u>Title</u>	<u>Country</u>	<u>Patent Number</u>	<u>Patent Date</u>
58014.130.1 	Adjustable Magnifier Structure Mountable on Various Lamp Stands	U.S.	6,088,173	July 11, 2000 (term expires Sept. 22, 2019 with payment of maintenance fees)
58014.131.1 	Integrated Fluorescent Lamp Device	U.S.	7,293,897	Nov. 13, 2007 (term expires March 16, 2026 with payment of maintenance fees)

5012900_2.DOC

EXHIBIT C

Trademarks

[See attached]

Ctry	Trademark	Status	Application Number	Registration Number
AU	OTTLITE ENJOY LIFE IN HD	Pending	1328633	
AU	CREATIVE HD	Registered	1291001	1291001
AU	OFFICE HD	Pending	1291003	
AU	READER'S HD	Pending	1291000	
AU	OTTLITE	Registered	1342889	1342889
AU	THE LEARNING LIGHT	Registered	884529	884529
BX	THE LEARNING LIGHT	Registered	884529	884529
CA	HIGH DEFINITION LIGHTING	Registered	1455818	TMA781425
CA	OTTLITE	Pending	1467446	
CA	ENJOY LIFE IN HD	Registered	1396606	TMA795843
CA	HIGH DEFINITION LIGHTING TECHNOLOGY	Registered	1293925	TMA699062
CA	THE LEARNING LIGHT	Registered	1285142	TMA757032
CA	OTT-LITE	Registered	1187478	TMA627635
CA	OTTLITE ENJOY LIFE IN HD	Registered	1396607	TMA753210
CA	OTTLITE ENJOY LIFE IN HD. & Design (1)	Registered	1396605	TMA753208
CA	OTT-LITE TECHNOLOGY	Registered	1187479	TMA627811
CA	OTT-LITE TECHNOLOGY THE SCIENCE OF NATURAL LIGHT & Design (1)	Registered	1187477	TMA636,156
CA	THE SCIENCE OF NATURAL LIGHT	Registered	1187480	TMA622892
CH	THE LEARNING LIGHT	Registered	884529	884529
CN	OTT-LITE & Design (1)	Registered	1247412	1247412
DE	OTT-LITE	Registered	826718	826718
DE	OTT-LITE TECHNOLOGY	Registered	831036	831036
DE	OTT-LITE TECHNOLOGY & Design (1)	Registered	831038	831038
DE	OTT-LITE TECHNOLOGY THE SCIENCE OF NATURAL LIGHT & Design (1)	Registered	831039	831039
DE	THE LEARNING LIGHT	Registered	884529	884529
DK	OTT-LITE	Registered	826718	826718
DK	OTT-LITE TECHNOLOGY	Registered	831036	831036
DK	OTT-LITE TECHNOLOGY & Design (1)	Registered	831038	831038

DK	OTT-LITE TECHNOLOGY THE SCIENCE OF NATURAL LIGHT & Design (1)	Registered	831039	831039
DK	THE SCIENCE OF NATURAL LIGHT	Registered	826717	826717
EM	OTTLITE ENJOY LIFE IN HD	Registered	008640286	008640286
EM	OTTLITE ENJOY LIFE IN HD. & Design (1)	Registered	008640443	008640443
EM	CREATIVE HD	Registered	8180499	8180499
EM	OFFICE HD	Registered	8180507	8180507
EM	READER'S HD	Registered	8180481	8180481
EM	OTTLITE	Registered	8845984	8845984
ES	THE LEARNING LIGHT	Registered	884529	884529
FI	OTT-LITE	Registered	826718	826718
FI	OTT-LITE TECHNOLOGY	Registered	831036	831036
FI	OTT-LITE TECHNOLOGY & Design (1)	Registered	831038	831038
FI	OTT-LITE TECHNOLOGY THE SCIENCE OF NATURAL LIGHT & Design (1)	Registered	831039	831039
FI	THE SCIENCE OF NATURAL LIGHT	Registered	826717	826717
FR	OTT-LITE	Registered	826718	826718
FR	OTT-LITE TECHNOLOGY	Registered	831036	831036
FR	OTT-LITE TECHNOLOGY & Design (1)	Registered	831038	831038
FR	OTT-LITE TECHNOLOGY THE SCIENCE OF NATURAL LIGHT & Design (1)	Registered	831039	831039
FR	THE SCIENCE OF NATURAL LIGHT	Registered	826717	826717
FR	LAMPE PLUME	Pending	103753257	
FR	THE LEARNING LIGHT	Registered	884529	884529
GB	OTT-LITE	Registered	826718	826718
GB	OTT-LITE TECHNOLOGY	Registered	831036	831036
GB	OTT-LITE TECHNOLOGY & Design (1)	Registered	831038	831038
GB	OTT-LITE TECHNOLOGY THE SCIENCE OF NATURAL LIGHT & Design (1)	Registered	831039	831039
GB	THE LEARNING LIGHT	Registered	884529	884529
GR	THE LEARNING LIGHT	Registered	884529	884529
HK	CREATIVE HD	Registered	301316033	301316033
HK	OFFICE HD	Registered	301316042	301316042

HK	READER'S HD	Registered	301316024	301316024
HK	OTT-LITE & Design (1)	Registered	200008607	200008607
IE	THE LEARNING LIGHT	Registered	884529	884529
IS	OTT-LITE	Registered	826718	826718
IS	OTT-LITE TECHNOLOGY	Registered	831036	831036
IS	OTT-LITE TECHNOLOGY & Design (1)	Registered	831038	831038
IS	OTT-LITE TECHNOLOGY THE SCIENCE OF NATURAL LIGHT & Design (1)	Registered	831039	831039
JP	OTT-LITE TECHNOLOGY	Registered	831036	831036
JP	THE LEARNING LIGHT	Registered	884529	884529
MX	THE LEARNING LIGHT	Registered	767871	929234
MX	OTT-LITE	Registered	767872	929952
MX	OTT-LITE HDLT	Registered	767879	928965
MX	OTT-LITE TECHNOLOGY	Registered	767873	929235
MX	OTT-LITE VISIONSAVER PLUS	Registered	767874	929236
MX	OTT-LITE NATURAL LIGHT SUPPLEMENT	Registered	767876	929237
NO	CREATIVE LIGHT	Registered	200303819	221688
NO	OTTLITE ENJOY LIFE IN HD	Registered	200910833	254561
NO	OTTLITE ENJOY LIFE IN HD. & Design (1)	Registered	200910834	254565
NO	CREATIVE HD	Registered	200902888	252321
NO	OFFICE HD	Registered	200902889	251270
NO	OTT-LITE	Registered	826718	826718
NO	OTT-LITE TECHNOLOGY	Registered	831036	831036
NO	OTT-LITE TECHNOLOGY & Design (1)	Registered	831038	831038
NO	OTT-LITE TECHNOLOGY THE SCIENCE OF NATURAL LIGHT & Design (1)	Registered	831039	831039
NO	READER'S HD	Registered	200902887	251269
NO	OTTLITE	Pending	201001175	
NO	THE LEARNING LIGHT	Registered	884529	884529
SE	OTT-LITE	Registered	826718	826718
SE	OTT-LITE TECHNOLOGY	Registered	831036	831036
SE	OTT-LITE TECHNOLOGY & Design (1)	Registered	831038	831038

SE	OTT-LITE TECHNOLOGY THE SCIENCE OF NATURAL LIGHT & Design (1)	Registered	831039	831039
SE	THE SCIENCE OF NATURAL LIGHT	Registered	826717	826717
SE	THE LEARNING LIGHT	Registered	884529	884529
US	IT'S LIKE NATURAL DAYLIGHT INDOORS	Registered	77/129,770	3,351,249
US	THE LEARNING LIGHT	Registered	75/927,523	2,421,453
US	CREATIVE HD	Registered	77/622,369	3,756,660
US	EASYVIEW	Registered	78/756,887	3,201,104
US	ENJOY LIFE IN HD	Registered	77/480,538	3,693,600
US	MULTI-FLEX CRAFT FLOOR LAMP	Registered	77/061,514	3,454,477
US	OFFICE HD	Registered	77/622,306	3,786,392
US	FLAWLESS ABSOLUTELY FLAWLESS	Registered	85/056,464	4,013,561
US	OTT-LITE	Registered	74/081,414	1,704,198
US	OTTLITE ENJOY LIFE IN HD	Registered	77/480,526	3,693,599
US	508	Registered	85/132,311	4,007,785
US	OTTLITE ENJOY LIFE IN HD. & Design (1)	Registered	77/480,570	3,693,602
US	OTTLITE	Registered	77/797,994	3,766,783
US	SEE DETAILS CLEARLY AND COLORS ACCURATELY	Pending	85/762,445	
US	OTT-LITE HIGH DEFINITION NATURAL LIGHTING	Registered	78/911,113	3,413,355
US	HIGH DEFINITION LIGHTING	Registered	77/274,433	3,593,323
US	OTT-LITE TECHNOLOGY	Registered	76/203,873	2,573,318
US	OTT-LITE VISION SAVER & Design (1)	Registered	75/672,661	2,592,054
US	READER'S HD	Registered	77/622,340	3,756,659
US	SEEING IS BELIEVING	Registered	78/713,606	3,267,759
US	TOTAL FLEX	Registered	77/122,993	3,402,715
US	BRING THE POWER OF NATURAL DAYLIGHT INDOORS	Registered	77/285,380	3,408,939
WO	OTT-LITE	Registered		826718
WO	OTT-LITE TECHNOLOGY	Registered		831036
WO	OTT-LITE TECHNOLOGY & Design (1)	Registered		831038

WO	OTT-LITE TECHNOLOGY THE SCIENCE OF NATURAL LIGHT & Design (1)	Registered		831039
WO	THE SCIENCE OF NATURAL LIGHT	Registered		826717
WO	THE LEARNING LIGHT	Registered		884529

SCHEDULE RE SECTION 2(b)

None.