

## TRADEMARK ASSIGNMENT COVER SHEET

Electronic Version v1.1  
Stylesheet Version v1.2

ETAS ID: TM767578

<b>SUBMISSION TYPE:</b>	RESUBMISSION
<b>NATURE OF CONVEYANCE:</b>	ASSIGNMENT OF THE ENTIRE INTEREST AND THE GOODWILL
<b>RESUBMIT DOCUMENT ID:</b>	900718601

## CONVEYING PARTY DATA

Name	Formerly	Execution Date	Entity Type
Fitness Anywhere LLC		08/26/2022	Limited Liability Company: DELAWARE

## RECEIVING PARTY DATA

<b>Name:</b>	JFXD TRX ACQ LLC
<b>Street Address:</b>	501 PALM TRAIL
<b>City:</b>	DELRAY BEACH
<b>State/Country:</b>	FLORIDA
<b>Postal Code:</b>	33843
<b>Entity Type:</b>	Limited Liability Company: FLORIDA

## PROPERTY NUMBERS Total: 41

Property Type	Number	Word Mark
Registration Number:	5456211	DUO TRAINER
Registration Number:	4674630	EFT
Registration Number:	4674631	EXPEDITIONARY FUNCTIONAL TRAINING
Registration Number:	2975844	FITNESS ANYWHERE
Registration Number:	4103996	FITNESS ANYWHERE
Registration Number:	3476009	FORCE TRAINING KIT
Registration Number:	3922984	GET WITH THE MOVEMENT
Registration Number:	5309188	INVIZI-MOUNT
Registration Number:	4018160	MAKE YOUR BODY YOUR MACHINE
Registration Number:	3328634	MAKE YOUR BODY YOUR MACHINE
Registration Number:	3463278	MAKE YOUR BODY YOUR MACHINE
Registration Number:	6011421	MOVEMENT IS A VITAL SIGN
Registration Number:	4187178	RIP
Registration Number:	4366625	SUSPENSION TRAINING
Registration Number:	3255160	SUSPENSION TRAINING
Registration Number:	3255161	SUSPENSION TRAINING
Registration Number:	4018159	TRX
Registration Number:	3384871	TRX

TRADEMARK

Property Type	Number	Word Mark
Registration Number:	3202696	TRX
Registration Number:	4731160	TRX
Registration Number:	4998892	TRX
Registration Number:	4542811	TRX
Registration Number:	6322902	MOVEMENT IS A VITAL SIGN
Registration Number:	4422454	TRX CORE
Registration Number:	4027129	TRX FORCE
Registration Number:	6139690	TRX M BODY STRAP INTO THE MOVEMENT
Registration Number:	4583899	TRX MAKE YOUR BODY YOUR MACHINE
Registration Number:	6049742	TRX ROCKER
Registration Number:	4129135	TRXTEAM
Registration Number:	3925283	TRX TRAINING CENTER
Registration Number:	4345798	TRX TRAINING CENTER
Registration Number:	4459672	TRX TRAINING ZONE
Registration Number:	2953907	VECTOR RESISTANCE
Registration Number:	4011271	X
Registration Number:	3329136	X
Registration Number:	4125533	XMOUNT
Registration Number:	4741049	
Serial Number:	90078548	BANDIT
Serial Number:	90363512	TRX CERTIFIED
Serial Number:	90593456	TRX TRAINING CLUB
Serial Number:	90360346	TRX LIVE

**CORRESPONDENCE DATA**

**Fax Number:**

*Correspondence will be sent to the e-mail address first; if that is unsuccessful, it will be sent using a fax number, if provided; if that is unsuccessful, it will be sent via US Mail.*

**Phone:** 2128598000

**Email:** teas@friedfrank.com

**Correspondent Name:** Jason Greenberg c/o Fried Frank et al

**Address Line 1:** 1 New York Plaza

**Address Line 2:** 27th Floor

**Address Line 4:** New York, NEW YORK 10004

**ATTORNEY DOCKET NUMBER:** 007587-00001

**NAME OF SUBMITTER:** Jason Greenberg

**SIGNATURE:** /Jason Greenberg/

**DATE SIGNED:** 11/14/2022

**Total Attachments: 61**



source=TRX - Closing Folder - CopyExecutedTRX - IP Assignment Agreement - (Executed)#page49.tif  
source=TRX - Closing Folder - CopyExecutedTRX - IP Assignment Agreement - (Executed)#page50.tif  
source=TRX - Closing Folder - CopyExecutedTRX - IP Assignment Agreement - (Executed)#page51.tif  
source=TRX - Closing Folder - CopyExecutedTRX - IP Assignment Agreement - (Executed)#page52.tif  
source=TRX - Closing Folder - CopyExecutedTRX - IP Assignment Agreement - (Executed)#page53.tif  
source=TRX - Closing Folder - CopyExecutedTRX - IP Assignment Agreement - (Executed)#page54.tif  
source=TRX - Closing Folder - CopyExecutedTRX - IP Assignment Agreement - (Executed)#page55.tif  
source=TRX - Closing Folder - CopyExecutedTRX - IP Assignment Agreement - (Executed)#page56.tif  
source=TRX - Closing Folder - CopyExecutedTRX - IP Assignment Agreement - (Executed)#page57.tif  
source=TRX - Closing Folder - CopyExecutedTRX - IP Assignment Agreement - (Executed)#page58.tif  
source=TRX - Closing Folder - CopyExecutedTRX - IP Assignment Agreement - (Executed)#page59.tif  
source=TRX - Closing Folder - CopyExecutedTRX - IP Assignment Agreement - (Executed)#page60.tif  
source=TRX - Closing Folder - CopyExecutedTRX - IP Assignment Agreement - (Executed)#page61.tif

## ASSIGNMENT OF INTELLECTUAL PROPERTY

This Assignment of Intellectual Property (this “Assignment”), effective as of August 26, 2022, is entered into by and between Fitness Anywhere LLC, a Delaware limited liability company, dba TRX and TRX Training (the “Debtor”), and JFXD TRX ACQ LLC, a Florida limited liability company (the “Assignee”).

**WHEREAS**, the Debtor and TRX Holdco, LLC, a Delaware limited liability company (“Holdco”) filed for bankruptcy protection under chapter 11 of the United States Code, 11 U.S.C. §§ 101 *et seq.* (the “Bankruptcy Code”), on June 8, 2022, in the United States Bankruptcy Court for the Central District of California, Santa Ana Division (the “Bankruptcy Court”), and were assigned Lead Case No.: 8:22-bk-10948-SC (for Holdco) being jointly administered with Case No.: 8:22-bk-10949-SC (for the Debtor).

**WHEREAS**, on August 25, 2022, the Bankruptcy Court entered an order approving, among other things, the sale of certain of the Debtor’s assets to the Assignee (the “Sale Order”) pursuant to the terms and conditions of that certain Asset Purchase Agreement by and among the Debtor, Holdco and JFXD Capital, LLC, a Florida limited liability company, dated as of August 26, 2022 (as amended, modified, or supplemented in accordance with its terms, the “Purchase Agreement”), pursuant to which, among other things, the Debtor agreed to assign all of its right, title and interest in certain Intellectual Property Rights to the Assignee, including: those certain patents and patent applications identified on Schedule A attached hereto (the “Assigned Patents”); those certain trademark registrations and applications identified on Schedule B attached hereto (the “Assigned Trademarks”); those certain copyright registrations and applications identified on Schedule C attached hereto (the “Assigned Copyrights”); and those certain internet domain name registrations identified on Schedule D attached hereto (the “Assigned Domain Names” and, together with the Assigned Patents, the Assigned Trademarks and the Assigned Copyrights, the “Assigned Intellectual Property”);

**NOW THEREFORE**, for good and valuable consideration, the receipt and sufficiency of which are hereby acknowledged, and in consideration of the mutual promises and the representations, warranties, covenants and agreements contained in this Assignment, and intending to be legally bound hereby, the parties hereto agree as follows:

1. Definitions. All capitalized terms not otherwise defined herein shall have the respective meanings ascribed to such terms in the Purchase Agreement.

2. Conveyance and Acceptance of Assigned Patents. The Debtor hereby sells, transfers, assigns, conveys and delivers to the Assignee, and the Assignee hereby purchases and acquires, all of the Debtor’s right, title and interest in and to the Assigned Patents, any and all patents and patent applications that claim priority to the Assigned Patents, including continuations, divisions, continuations-in-part, reissues and reexaminations thereof, all rights of action pertaining to the Assigned Patents, including the right to sue and recover for past, present and future infringement thereof, the right to secure registration of the Assigned Patents and of this Assignment, the right to initiate other proceedings before all governmental entities with respect to the Assigned Patents and the right to claim priority, file foreign counterparts and make applications for reissue and reexamination with respect to the Assigned Patents.

3. Conveyance and Acceptance of Assigned Trademarks. The Debtor hereby sells, transfers, assigns, conveys and delivers to the Assignee, and the Assignee hereby purchases and acquires, all of the Debtor's right, title and interest in and to the Assigned Trademarks, the goodwill of the business connected with the use of and symbolized by the Assigned Trademarks, the right to sue and recover for past, present and future infringement thereof, the right to secure registration of the Assigned Trademarks and of this Assignment and the right to initiate other proceedings before all governmental entities with respect to the Assigned Trademarks. Debtor and Assignee acknowledge that with respect to the United States intent-to-use trademark applications included in the Assigned Trademarks, the transfer of such applications accompanies, pursuant to the Purchase Agreement, the transfer of Sellers' business, or that portion of the business to which the trademarks pertain, which business is ongoing and existing.

4. Conveyance and Acceptance of Assigned Copyrights. The Debtor hereby sells, transfers, assigns, conveys and delivers to the Assignee, and the Assignee hereby purchases and acquires, all of the Debtor's right, title and interest in and to the Assigned Copyrights, the right to sue and recover for past, present and future infringement thereof, the right to secure registration of the Assigned Copyrights and of this Assignment and the right to initiate other proceedings before all governmental entities with respect to the Assigned Copyrights.

5. Conveyance and Acceptance of Assigned Domain Names. The Debtor hereby sells, transfers, assigns, conveys and delivers to the Assignee, and the Assignee hereby purchases and acquires, all of the Debtor's right, title and interest in and to the Assigned Domain Names, the goodwill of the business connected with the use of and symbolized by the Assigned Domain Names, the right to sue and recover for past, present and future infringement thereof, the right to secure registration of the Assigned Domain Names and of this Assignment and the right to initiate other proceedings before all Registering Authorities and governmental entities with respect to the Assigned Domain Names.

6. Recordation.

a. Authorization. The Debtor hereby authorizes and requests that the Commissioner for Patents, the Commissioner for Trademarks, the Register of Copyrights and any other sovereign official holding a corresponding position of authority in any other jurisdiction record this Assignment. The Debtor will, at the Assignee's request, take any and all reasonable actions, including the execution, acknowledgment and delivery of any and all documents, that the Assignee may reasonably request to record and perfect the Assignee's interest in and to the Assigned Patents, the Assigned Trademarks and the Assigned Copyrights.

b. Domain Names. The Debtor hereby authorizes each internet domain name registrar (the "Registering Authority") of the Assigned Domain Names to transfer and record in the name of the Assignee ownership of and administrative contact for all of the Assigned Domain Names. The Debtor will, at the Assignee's request, take any and all reasonable actions, including the execution, acknowledgment and delivery of any and all documents, that the Assignee may reasonably request to record and perfect the Assignee's interest in and to the Assigned Domain Names. Without limiting the foregoing, at the Assignee's request, the Debtor will cooperate with the Assignee to (i) complete any registrant name change agreement or other form required by any applicable Registering Authority to effect or record the assignment

contemplated by this Assignment; (ii) submit those registrant name change agreements or other forms to the Registering Authority in accordance with the Registering Authority's policies and rules; and (iii) take any further actions required by the Registering Authority's policies and rules to transfer the Assigned Domain Names to the Assignee.

7. Further Assurances. Without limiting the Debtor's obligations in Section 6, each party hereto shall do and perform all such further acts and things, and shall execute and deliver all such other agreements, certificates, instruments and documents, as the other party hereto may reasonably request in order to carry out and accomplish the purpose of this Assignment and all actions contemplated hereby.

8. Terms of the Purchase Agreement. The terms of the Purchase Agreement, including, but not limited to, the Debtor's and the Assignee's representations, warranties, covenants, agreements and indemnities, are incorporated herein by this reference. The provisions of this Assignment are subject to the terms and conditions of the Purchase Agreement. In the event of any conflict or inconsistency between the terms of the Purchase Agreement and the terms hereof, the terms of the Purchase Agreement shall govern, supersede and prevail.

9. Amendment; Modification. Neither this Assignment nor any of the terms hereof may be terminated, amended, supplemented or modified orally, but only by an instrument in writing signed by the Debtor and the Assignee.

10. Governing Law. This Assignment shall be governed by and construed in accordance with the Bankruptcy Code, to the extent applicable, and, where state law is implicated, the internal laws of the state of California, without giving effect to any principles of conflicts of law. Without limiting any party's right to appeal any Order of the Bankruptcy Court, the parties agree that if any dispute arises out of or in connection with this Assignment or any of the documents executed hereunder or in connection herewith, the Bankruptcy Court shall have exclusive personal and subject matter jurisdiction and shall be the exclusive venue to resolve any and all disputes relating to this Assignment. The Bankruptcy Court shall have sole jurisdiction over such matters and the parties affected thereby, and Assignee and Debtor each hereby consent and submit to such jurisdiction; provided, however, that if the Bankruptcy Cases have closed and cannot be reopened, the parties agree to unconditionally and irrevocably submit to the exclusive jurisdiction of the United States District Court for the district in which the Bankruptcy Court is located and any appellate court thereof, for the resolution of any such claim or dispute. The parties hereto hereby irrevocably waive, to the fullest extent permitted by applicable law, any objection which they may now or hereafter have to the laying of venue of any such dispute brought in such court or any defense of inconvenient forum for the maintenance of such dispute. Each of the parties hereto agrees that a judgment in any such dispute may be enforced in other jurisdictions by suit on the judgment or in any other manner provided by law. In the event any such action, suit or proceeding is commenced, the parties hereto hereby agree and consent that service of process may be made, and personal jurisdiction over any party hereto in any such action, suit or proceeding may be obtained, by service of a copy of the summons, complaint and other pleadings required to commence such action, suit or proceeding upon the party at the address of such party set forth in Section 12.8 of the Purchase Agreement, unless another address has been designated by such party in a notice given to the other party in accordance with the provisions of Section 12.8 of the Purchase Agreement.

11. Counterparts. This Assignment may be executed in separate counterparts, each of which shall be deemed an original, but all of which together shall constitute one and the same instrument. This Assignment shall become effective when counterparts have been signed by each of the parties and delivered by facsimile or other means to the other party. Signatures transmitted by facsimile or electronically shall be deemed to have the same force and effect as original signatures.

[Signatures Follow on Next Page.]



IN WITNESS WHEREOF, the parties hereto have duly executed this Assignment as of the date set forth above.

**DEBTOR:**

**FITNESS ANYWHERE LLC dba  
TRX AND TRX TRAINING**

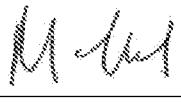
By:  \_\_\_\_\_

Name: Brent Leffel

Title: Chairman

[Signatures Continued on Following Page.]

**ASSIGNEE:**

JFXD TRX ACQ LLC,  
a Florida limited liability company

BY: JFXD Capital LLC, as Manager

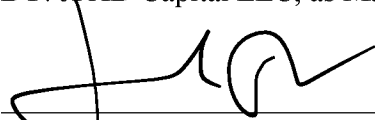
A handwritten signature in black ink, appearing to read 'Jack Daly', is written over a horizontal line.



Name: Jack Daly

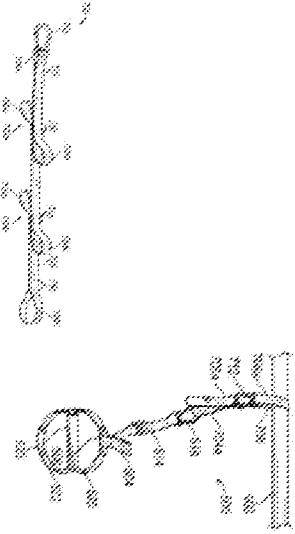
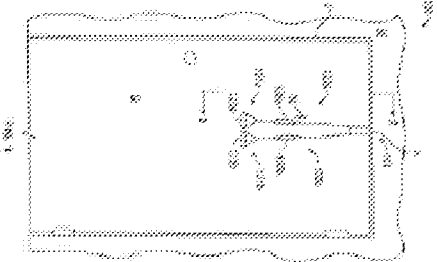

Title: Authorized Signatory

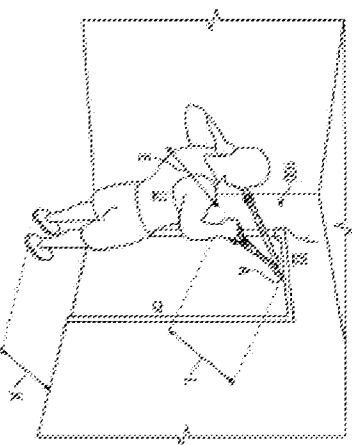
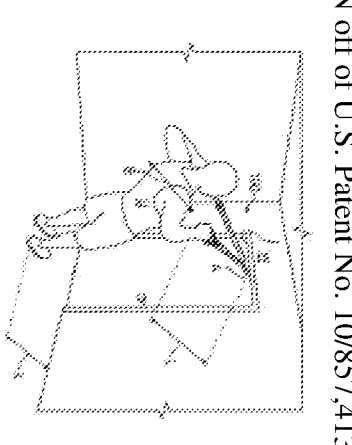
Schedule A  
Patents

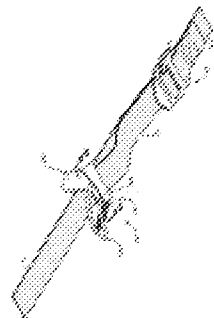
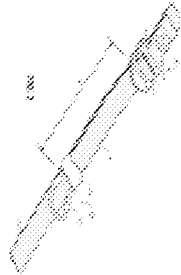
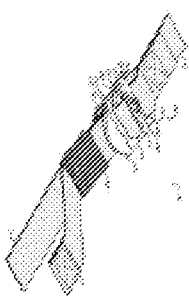

U.S. Patents / Applications	PCT Applications	National Stage Patents / Applications
<p>Patent No. 10,245,460 APPARATUS, KIT, AND METHOD FOR PERFORMING STRAP-BASED EXERCISES Expires 5/10/2037</p> 	<p>PCT App. No. PCT/US17/63062 APPARATUS, KIT, AND METHOD FOR PERFORMING STRAP-BASED EXERCISES Expired</p> 	<p>AU Patent No. 2017363883 Issued – Expires 11/22/2037 BR App. No. BR112019010262-0 Request for examination filed CA Patent No. 3,044,600 Issued - Expires 11/22/2037 CN Patent No. ZL 201780077946.X Allowed CN App. No. 202011204351.6 DIV of CN App. No. 201780077946.X Pending EP App. No. 17873935.5 Pending JP App. Patent No. 6632048 Expires 11/22/2037</p>
<p>U.S. Patent No. 10,857,413 APPARATUS, KIT, AND METHOD FOR PERFORMING STRAP-BASED EXERCISES</p>		

U.S. Patents / Applications	PCT Applications	National Stage Patents / Applications
<p>*CON off of U.S. Patent No. 10,245,460. Expires 11/22/2036</p>		
 <p>U.S. App. No. 17/094,487 Filed 11/10/2020 APPARATUS, KIT, AND METHOD FOR PERFORMING STRAP-BASED EXERCISES</p>		
 <p>*CON off of U.S. Patent No. 10/857,413</p>		
U.S. Patents / Applications	PCT Applications	National Stage Patents / Applications

U.S. Patents / Applications	PCT Applications	National Stage Patents / Applications
Patent No. 9,155,931 STRAP RESTRAINT APPARATUS Expires 7/14/2032 	PCT App. No. PCT/US11/49369 STRAP RESTRAINT APPARATUS Expired 	AU Patent No. 2011293171 Expires 8/27/2030 CN Patent No. ZL201180048632.X Expires 8/27/2030 JP Patent No. 5969478 Expires 8/27/2030 EP Patent No. 2608850 Issued in FR, DE, UK Expires 8/27/2030
Patent No. 8,840,532 STRAP ADJUSTER AND KEEPER AND METHOD OF STRAP CONTROL Expires 5/23/2032 	PCT App. No. PCT/US12/48525 STRAP ADJUSTER AND KEEPER AND METHOD OF STRAP CONTROL Expired 	EP Patent No. 2736607 Issued in FR, DE, UK Expires 7/27/2032 CN Patent No. ZL201280044774.3 Expires 7/27/2032 CA Patent No. 2843423 Expires 7/27/2032 HK Patent No. HK1197659 Expires 11/7/2034

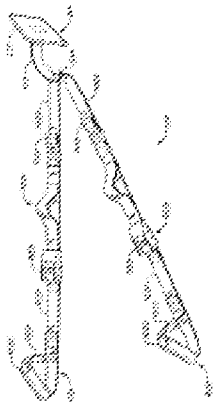
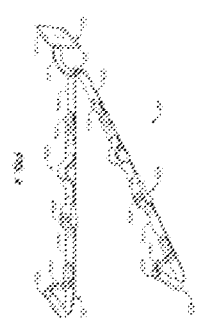
U.S. Patents / Applications	PCT Applications	National Stage Patents / Applications
Patent No. 7,762,932 INELASTIC EXERCISE DEVICE HAVING A LIMITED RANGE Expires 11/30/2027 	PCT App. No. PCT/US08/76548 Expired INELASTIC EXERCISE DEVICE HAVING A LIMITED RANGE 	EP Patent No. 2195096 Expires 9/16/2028 Pending applications in FR, DE, UK AU Patent No. 2008302430 Expires 9/16/2028 BR Patent No. PI 0815870-3 Expires 9/16/2028 CA Patent No. 2699778 Expires 9/16/2028 ID Patent No. ID P000035074 Expires 9/16/2028 IL Patent No. 204530 Expires 9/16/2028 IN App. No. 2436/DELNP/2010 Pending MX Patent No. 305318 Expires 9/16/2028 MY Patent No. MY-161314-A Expires 9/16/2028 NZ Patent No. 584635 Expires 9/16/2028 PH Patent No. 12010500561 Expires 9/16/2028 UA Patent No. 100386 Expires 9/16/2028 VN Patent No. 11286 Expires 9/16/2028 ZA Patent No. 2010/02658 Expires 9/16/2028

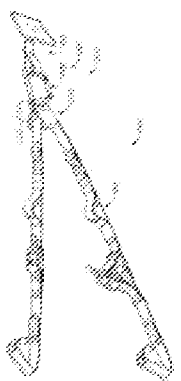
U.S. Patents / Applications	PCT Applications	National Stage Patents / Applications																																																																																								
Patent No. 8,083,653 EXERCISE DEVICE HAVING A DOOR ANCHOR Expires 11/30/2027 	PCT App. No. PCT/US08/76551 EXERCISE DEVICE HAVING A DOOR ANCHOR Expired 	EP App. No. 08831856.3 Allowed <b>NATIONAL VALIDATIONS</b> Austria, Czech Republic, Denmark, Finland, France, Germany, Greece, Italy, Luxembourg, Netherlands, Poland, Romania, Spain, Sweden, Turkey, and the United Kingdom <table border="1" data-bbox="274 1354 1421 1980"> <tbody> <tr> <td>AU</td> <td>Patent</td> <td>No.</td> <td>2008302432</td> </tr> <tr> <td colspan="4">Expires 9/16/2028</td> </tr> <tr> <td>CA</td> <td>Patent</td> <td>No.</td> <td>2699972</td> </tr> <tr> <td colspan="4">Expires 9/16/2028</td> </tr> <tr> <td>ID</td> <td>Patent</td> <td>No.</td> <td>W00201001174</td> </tr> <tr> <td colspan="4">Expires 9/16/2028</td> </tr> <tr> <td>IN</td> <td>Patent</td> <td>No.</td> <td>313487</td> </tr> <tr> <td colspan="4">Expires 9/16/2028</td> </tr> <tr> <td>JP</td> <td>Patent</td> <td>No.</td> <td>5561734</td> </tr> <tr> <td colspan="4">Expires 9/16/2028</td> </tr> <tr> <td>MX</td> <td>Patent</td> <td>No.</td> <td>307366</td> </tr> <tr> <td colspan="4">Expires 9/16/2028</td> </tr> <tr> <td>MY</td> <td>Patent</td> <td>No.</td> <td>MY-159409-A</td> </tr> <tr> <td colspan="4">Expires 9/16/2028</td> </tr> <tr> <td>NZ</td> <td>Patent</td> <td>No.</td> <td>584644</td> </tr> <tr> <td colspan="4">Expires 9/16/2028</td> </tr> <tr> <td>PH</td> <td>Patent</td> <td>No.</td> <td>1-2010-500563</td> </tr> <tr> <td colspan="4">Expires 9/16/2028</td> </tr> <tr> <td>SG</td> <td>Patent</td> <td>N.</td> <td>159610</td> </tr> <tr> <td colspan="4">Expires 9/16/2028</td> </tr> <tr> <td>VN</td> <td>Patent</td> <td>No.</td> <td>11287</td> </tr> <tr> <td colspan="4">Expires 9/16/2028</td> </tr> </tbody> </table>	AU	Patent	No.	2008302432	Expires 9/16/2028				CA	Patent	No.	2699972	Expires 9/16/2028				ID	Patent	No.	W00201001174	Expires 9/16/2028				IN	Patent	No.	313487	Expires 9/16/2028				JP	Patent	No.	5561734	Expires 9/16/2028				MX	Patent	No.	307366	Expires 9/16/2028				MY	Patent	No.	MY-159409-A	Expires 9/16/2028				NZ	Patent	No.	584644	Expires 9/16/2028				PH	Patent	No.	1-2010-500563	Expires 9/16/2028				SG	Patent	N.	159610	Expires 9/16/2028				VN	Patent	No.	11287	Expires 9/16/2028			
AU	Patent	No.	2008302432																																																																																							
Expires 9/16/2028																																																																																										
CA	Patent	No.	2699972																																																																																							
Expires 9/16/2028																																																																																										
ID	Patent	No.	W00201001174																																																																																							
Expires 9/16/2028																																																																																										
IN	Patent	No.	313487																																																																																							
Expires 9/16/2028																																																																																										
JP	Patent	No.	5561734																																																																																							
Expires 9/16/2028																																																																																										
MX	Patent	No.	307366																																																																																							
Expires 9/16/2028																																																																																										
MY	Patent	No.	MY-159409-A																																																																																							
Expires 9/16/2028																																																																																										
NZ	Patent	No.	584644																																																																																							
Expires 9/16/2028																																																																																										
PH	Patent	No.	1-2010-500563																																																																																							
Expires 9/16/2028																																																																																										
SG	Patent	N.	159610																																																																																							
Expires 9/16/2028																																																																																										
VN	Patent	No.	11287																																																																																							
Expires 9/16/2028																																																																																										

U.S. Patents / Applications	PCT Applications	National Stage Patents / Applications
Patent No. 8,043,197 EXERCISE DEVICE HAVING INELASTIC STRAPS AND INTERCHANGEABLE PARTS Expires 11/30/2027 	PCT App. No. PCT/US08/76546 EXERCISE DEVICE HAVING INELASTIC STRAPS AND INTERCHANGEABLE PARTS Expired 	CN Patent No. ZL200880107340.7 Expires 9/16/2028 HK Patent No. HK1145657 Expires 9/16/2028 AU Patent No. 2008302429 Expires 9/16/2028 CA Patent No. 2715413 Expires 9/16/2028 CO Patent No. 4197 Expires 9/16/2028 ID Patent No. P000038793 Expires 9/16/2028 IL Patent No. 204533 Expires 9/16/2028 IN Patent No. 32983 Expires 9/16/2028 MY Patent No. MY-160171-A Expires 9/16/2028 NZ Patent No. 584630 Expires 9/16/2028 PH Patent No. 1-2010-500560 Expires 9/16/2028 VN Patent No. 1-0019340-000 Expires 9/16/2028

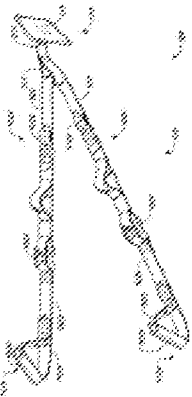
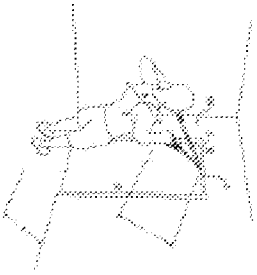
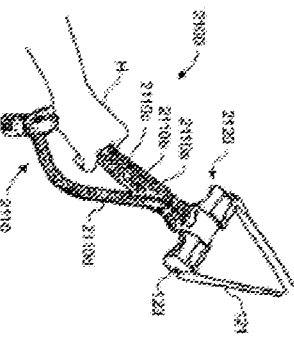
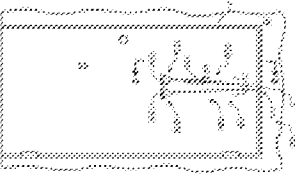

U.S. Patents / Applications	PCT Applications	National Stage Patents / Applications
<p>U.S. Patent No. 7,044,896 EXERCISE DEVICE INCLUDING ADJUSTABLE, INELASTIC STRAPS Expires 8/15/2023</p> 	<p>PCT App. No. PCT/US04/10836 EXERCISE DEVICE WITH ADJUSTABLE INELASTIC STRAPS Expired</p> 	<p>CA Patent No. 2521859 Expires 4/8/2024 CA Patent No. 2634464 (Divisional of CA. Patent No. 2521859) Expires 4/8/2024 EP Patent No. 1615704 Issued in FR, DE and UK Expires 4/8/2024 EP Patent No. 1945319 Issued in FR, DE and UK Expires 11/7/2026 AU Patent No. 2006332594 Expires 11/7/2026 BR. Patent No. PI 0619689-6 Expires 11/7/2026 CA Patent No. 2628774 Expires 11/7/2026 IL Patent No. 191205 Expires 11/7/2026 IN Patent No. 289432 Expires 11/7/2026 JP Patent No. 5731099 Expires 11/7/2026 KR Patent No. 10-1142216 Expires 11/7/2026</p>
<p>U.S. Patent No. 7,090,622 (Continuation of 7,044,896) EXERCISE DEVICE GRIPS AND ACCESSORIES FOR EXERCISE DEVICES Expires 4/9/2023</p> 	<p>PCT App. No. PCT/US06/60596 COMBINATION GRIP FOR AN EXERCISE DEVICE Expired</p> 	<p>CA Patent No. 2521859 Expires 4/8/2024 CA Patent No. 2634464 (Divisional of CA. Patent No. 2521859) Expires 4/8/2024 EP Patent No. 1615704 Issued in FR, DE and UK Expires 4/8/2024 EP Patent No. 1945319 Issued in FR, DE and UK Expires 11/7/2026 AU Patent No. 2006332594 Expires 11/7/2026 BR. Patent No. PI 0619689-6 Expires 11/7/2026 CA Patent No. 2628774 Expires 11/7/2026 IL Patent No. 191205 Expires 11/7/2026 IN Patent No. 289432 Expires 11/7/2026 JP Patent No. 5731099 Expires 11/7/2026 KR Patent No. 10-1142216 Expires 11/7/2026</p>

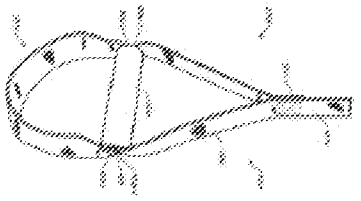
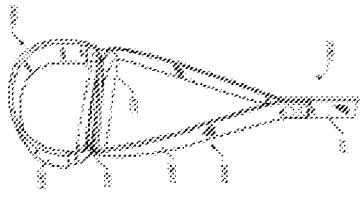
U.S. Patents / Applications	PCT Applications	National Stage Patents / Applications
<p>U.S. Patent No. 7,806,814 (CIP of '896 and '622) COMBINATION GRIP FOR AN EXERCISE DEVICE Expires 10/23/2024</p> 	<p>PCT App. No. PCT/US08/76544 COMBINATION GRIP FOR AN EXERCISE DEVICE Expired</p> 	<p>MX Patent No. 305921 Expires 11/7/2026  RU Patent No. 2407577 Expires 11/7/2026  SG Reg. No. 175563 Expires 11/7/2026</p>
<p>U.S. Application No. 12/209,151 COMBINATION GRIP FOR AN EXERCISE DEVICE Abandoned</p>	<p>PCT App. No. PCT/US08/76544 COMBINATION GRIP FOR AN EXERCISE DEVICE Expired</p>	<p>MX Patent No. 318904 Expires 9/16/2028  MY Patent No. MY-166330-A Expires 9/16/2028  NZ Patent No. 584628 Expires 9/16/2028  PH Patent No. 1-2010-500559 Expires 9/16/2028  SG. Reg. No. 159605 Expires 9/16/2028  VN Patent NO. 25587 Expires 9/16/2028</p>

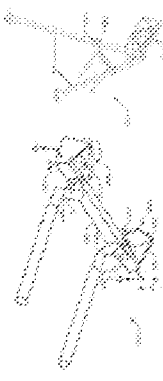
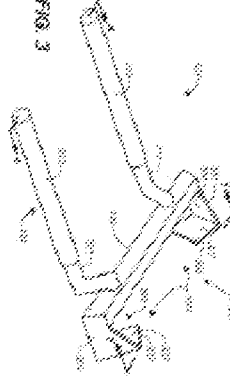
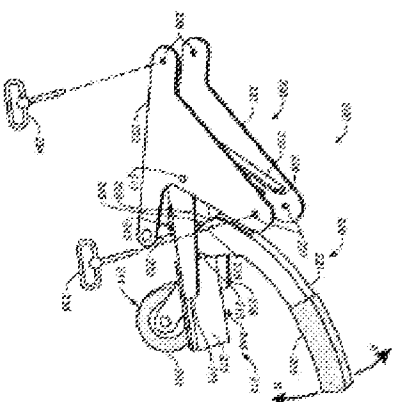
U.S. Patents / Applications		PCT Applications	National Stage Patents / Applications
Patent No. 9,199,119 <b>EXERCISE BAR ATTACHMENT AND METHOD</b> Expires 2/20/2034 	PCT App. No. PCT/US11/62646 <b>EXERCISE BAR ATTACHMENT AND METHOD</b> Expired 	EP Patent No. 2646118 Issued in FR, DE and GB Expires 11/30/2031 AU Patent No. 20111336633 Expires 11/30/2031 CA Patent No. 9819626 Expires 11/30/2031 CN Pat. No. ZL 201180065181.0 Expires 11/30/2031 JP Patent No. 6009452 Expires 11/30/2031 U.S. Maintenance Fee Paid \$1,880.00 on 07/13/21	
Patent No. 8,628,059 <b>ASSEMBLY FOR A MOVABLE FRAME</b> Expires 10/23/2024 			

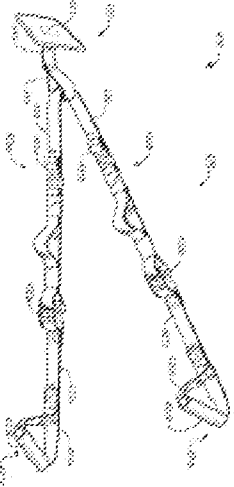
U.S. Patents / Applications	PCT Applications	National Stage Patents / Applications
Patent No. 7,785,244 COMBINATION GRIP FOR AN EXERCISE DEVICE Expires 11/30/2027 		
Patent No. 7,722,508 COMBINATION GRIP FOR AN EXERCISE DEVICE Expires 4/9/2023 		

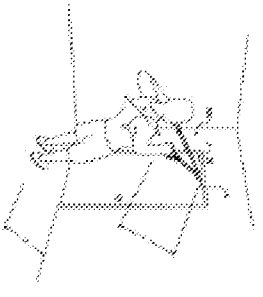
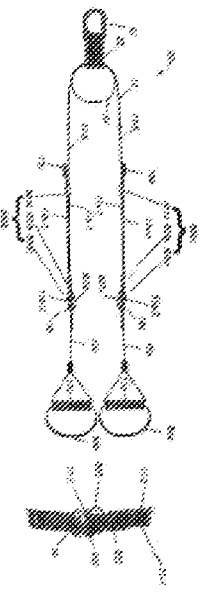
U.S. Patents / Applications	PCT Applications	National Stage Patents / Applications
<p>Patent No. 7,651,448  METHOD OF USING AN ADJUSTABLE EXERCISE DEVICE  Expires 8/18/2023</p> 		<p>U.S. Maintenance Fee Paid \$3,850.00 on 07/13/21</p>
<p>Patent No. 9,433,258  *Continuation in Part of U.S. Patent No. 8,840,532  STRAP ADJUSTER AND KEEPER  Expires 8/19/2031</p> 		

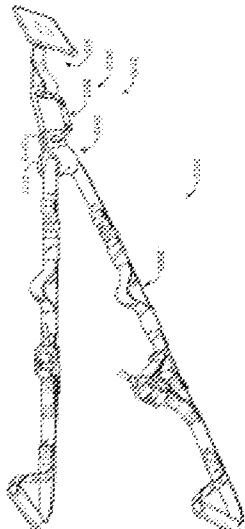
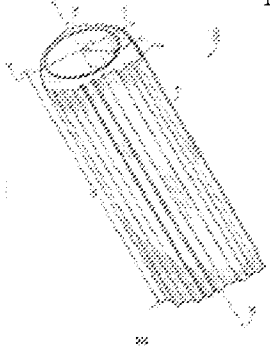
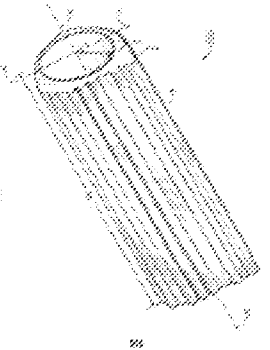
U.S. Patents / Applications	PCT Applications	National Stage Patents / Applications
<p data-bbox="1234 94 1412 703">           Patent No. 8,469,864            EXERCISE DEVICE HAVING INELASTIC STRAPS AND INTERCHANGEABLE PARTS            Expires 11/30/2027         </p> 		
<p data-bbox="722 94 901 703">           U.S. App. No. 16/592,337            MULTI-ZONAL ROLLER AND METHOD OF USE THEREOF            Pending         </p> 	<p data-bbox="795 724 901 1333">           PCT App. No. PCT/US20/54038            MULTI-ZONAL ROLLER AND METHOD OF USE THEREOF         </p> 	

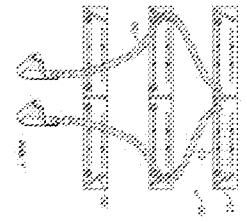
U.S. Patents / Applications		PCT Applications		National Stage Patents / Applications	
U.S. App. No. 62/860,477 (Provisional Application) EXERCISE SYSTEM FOR USING VARIABLE LOCATION ANCHORS AND VARIABLE BIASING ELEMENTS, AND METHOD OF USE THEREOF Expired 		PCT App. No. PCT/US20/37443 Filed 6/12/2020			

TRADEMARK  
 REEL: 007847 FRAME: 0429

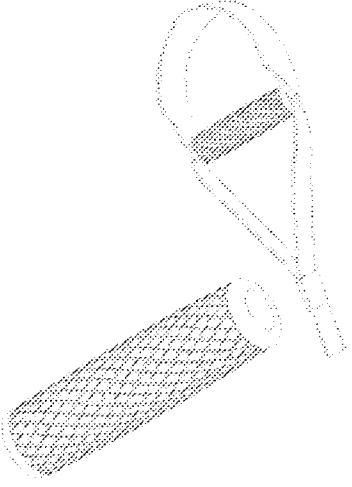
National	International
U.S. Patent No. D669,945 Expires 10/30/2026 HAND GRIP FOR AN EXERCISE DEVICE 	AU Patent No. 341028 Expires 1/25/2022 BR Patent No. BR30201200023111 Expires 1/20/2037 CN Patent No. ZL201230018859.7 Expires 1/30/2022 EU Patent No. 001979873 Expires 1/23/2027 JP Patent No. 1442513 Expires 4/27/2032 UK 90019798730001

U.S. Patent No. D831,764  
 DUAL STITCH PATTERN FOR A FLEXIBLE STRAP  
 Expires 10/23/2033

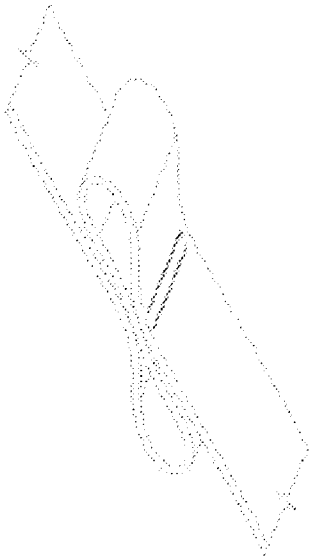

Renewal: 23 January 2027

AU Patent No. 201713501  
 Expires 6/9/2027 (10 years)

CN Patent No. 201730234242.1  
 Expires 6/9/2027 (10 years)

UK Reg. No. 6013645  
 Expires 6/9/2042 (25 years)

**La Hague Design Registration**  
 Renewal: **09.06.2022** (**09.06.2017** Initial  
 Registration)  
 Up to 15 years in La Hague, then National  
 Designations

FR Reg. No. DM/098254  
 Expires 6/9/2042 (25 years)

DE Reg. No. DM/098254  
 Expires 6/9/2042 (25 years)

AU Patent No. 201713480  
 Expires 6/9/2027 (10 years)

CN Patent No. ZL201730233813.X  
 Expires 6/9/2027 (10 years)

UK Patent No. 6013639  
 Expires 6/9/2042 (25 years)

**La Hague Design Registration**  
 Renewal: **09.06.2022** (**09.06.2017** Initial  
 Registration)  
 Up to 15 years in La Hague, then National  
 Designations

Patent No. D818,809  
 STITCHING PROTECTOR FOR FLEXIBLE STRAPS  
 Expires 5/29/2033 (15 years)

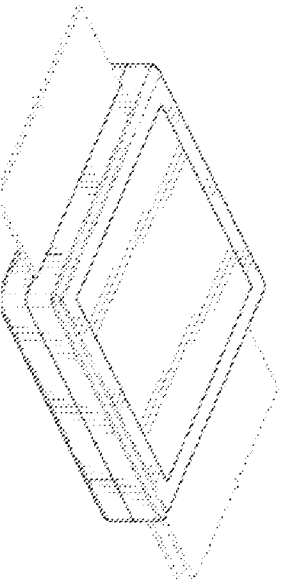

TRADEMARK

REEL: 007847 FRAME: 0430

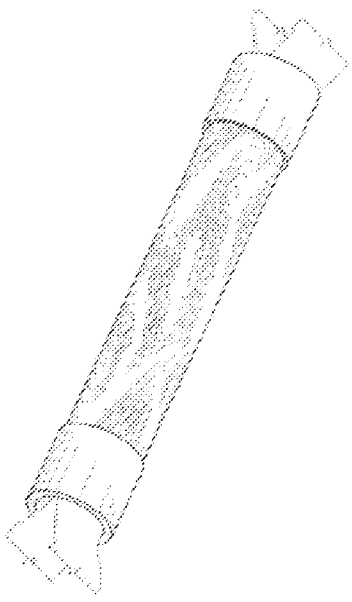

<p>Patent No. D820,063                  WOOD MOTIF HANDLE FOR HOLDING A FLEXIBLE STRAP                  Expires 6/12/2033</p>	<p>FR Reg. No. DM/098251                  Expires 6/9/2042 (25 years)                  DE Reg. No. DM/098251                  Expires 6/9/2042 (25 years)                  JP Reg. No. DM/098251 (JP Design Reg. No. 1650872) Expires 6/9/2042(25 years)</p>
<p>Patent No. D808,251                  FLATTENED DUAL-STACKED LENGTHENING</p>	<p>AU Patent No. 201713486                  Expires 6/9/2027                  CN Patent No. 201730233510.8                  Expires 6/9/2027                  UK Patent No. 6013640                  Expires 6/9/2042</p>
	<p><b>La Hague Design</b>  <b>Renewal: 09.06.2022 (09.06.2017 Initial Registration)</b>  <b>Up to 15 years in La Hague, then National Designations</b>                  FR Reg. No. DM/098252                  Expires 6/9/2042                  DE Reg. No. DM/098252                  Expires 6/9/2042                  JP Reg. No. DM/098252 (JP Design Reg. No. 1650873) Expires 6/9/2042</p>
<p>Patent No. D808,251                  FLATTENED DUAL-STACKED LENGTHENING</p>	<p>AU Patent No. 201713498                  Expires 6/9/2027</p>

MECHANISM FOR A FLEXIBLE STRAP  
Expires 1/23/2033

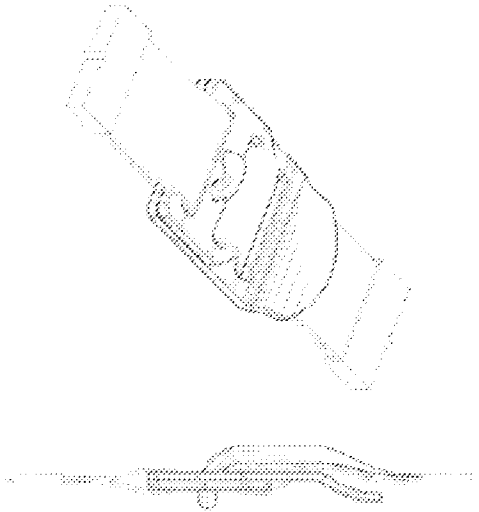

CN Patent No. 201730234243.6  
Expires 6/9/2027

UK Patent No. 6013642  
Expires 6/9/2042

**La Hague IR DM/098,364**  
**Renewal: 09.06.2022 (09.06.2017 Initial**  
**Registration)**  
**Up to 15 years in La Hague, then National**  
**Designations**

FR Reg. No. DM/098364  
Expires 6/9/2042 (25 years)

DE Reg. No. DM/098364  
Expires 6/9/2042 (25 years)

JP Reg. No. DM/098364 (JP Design Reg.  
No. 1650874)  
Expires 6/9/2042 (25 years)

No international filings

Patent No. D842,946  
EXERCISE APPARATUS WALL ANCHOR  
Expires 3/12/2034 (15 years from grant)

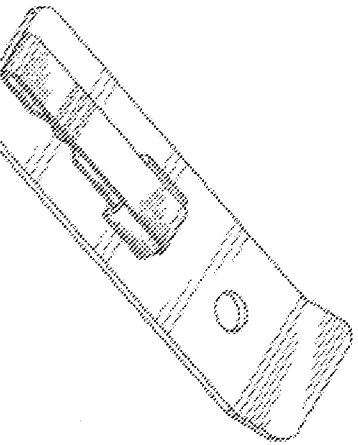

Application No. 29/587,143

AU Patent No. 201713494

TRADEMARK

REEL: 007847 FRAME: 0432

CROSSING LINE MOTIF HANDLE FOR HOLDING A  
 FLEXIBLE STRAP  
 Abandoned 1/8/2019

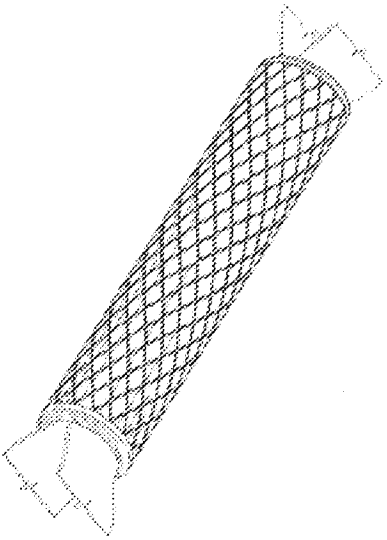

Expires 6/9/2027 (10 years from filing)

CN Patent No. ZL201730233803.6

Expires 6/9/2027 (10 years from filing – pre 2021)

UK Patent No. 6013641

Expires 6/9/2042 (25 years)

**La Hague Design Registration**

**Renewal: 09.06.2022 (09.06.2017 Initial Registration)**

**Up to 15 years in La Hague, then National Designations**

FR Reg. No. DM/098253

Expires 6/9/2042 (25 years)

DE Reg. No. DM/098253

Expires 6/9/2042 (25 years)

**La Hague Design Registration**

**Renewal: March 30, 2025**

**Up to 15 years in La Hague, then National Designations**

Canada: Expires: March 30, 2035 (15 years)

Europe: Expires: March 30, 2045 (25 years)

UK: 8208420001000 Renewal: 30 March 2025 (up to 25 years)

Korea: Expires: March 30, 2040 (20 years)

Vietnam: Pending

Israel: Expires: March 30, 2045 (25 years)

Japan: Expires: March 30, 2045 (25 years)

Russia: Expires: March 30, 2045 (25 years)

Singapore: Expires: March 30, 2035 (15 years)

**National Stages (Non La Hague):**

U.S. Registration D921213  
 MULTI-ZONAL ROLLER  
 International Reg. No. DM/208482  
 Expiration: June 1, 2036

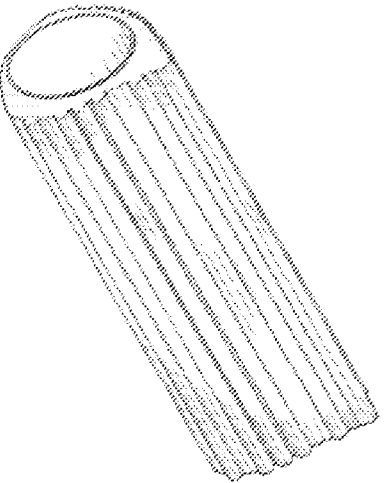

TRADEMARK

REEL: 007847 FRAME: 0433

<p>Application No. 29/759,030 -Filed 11/19/2020                  International Request: DM/212,442                  EXERCISE BAND HANDLE (D) - Pending</p>	<p>Chinese Design Patent No. ZL 202030119823.2                  Expires 3/30/30                  Mexican Design No.MX/F/2020/001247                  Filed March 30, 2035 (15 years)</p>
<p>Application No. 29/735,218 -Filed 5/19/2020                  REMOVABLE UNIBLOCK EXERCISE BAND HANDLE (A)                  Pending</p> <p>Application No. 29/735,224 (B) - Filed 5/19/2020                  REMOVABLE COVERED EXERCISE BAND HANDLE                  Pending</p>	<p><b>La Hague Design Registration                  Renewal: November 19, 2025 – DM/212,442                  Up to 15 years in La Hague, then National                  Designations</b></p> <p>Canada: Expires Nov. 19, 2035 (15 years)                  EP: Expires Nov. 19, 2045 (25 years)                  UK: Expires Nov. 19, 2045 (25 years)                  Israel: Expires Nov. 19, 2045 (25 years)                  Japan: Expires Nov. 19, 2045 (25 years)                  Korea: Expires Nov. 19, 2040 (20 years)                  Mexico: Expires Nov. 19, 2035 (15 years)                  Russia: Expires Nov. 19, 2045 (25 years)                  Singapore: Expires Nov. 19, 2035 (15 years)                  Vietnam: Pending</p> <p>CN App. No. 202030702925.7                  Filed 11/19/2020 – Pending</p> <p>CN App. No. 202030702923.8                  Filed 11/19/2020</p>
<p>Application No. 29/735,226 / Filed 5/19/20                  REMOVABLE COVERED SIMPLE EXERCISE BAND                  HANDLE (C) - Pending</p>	

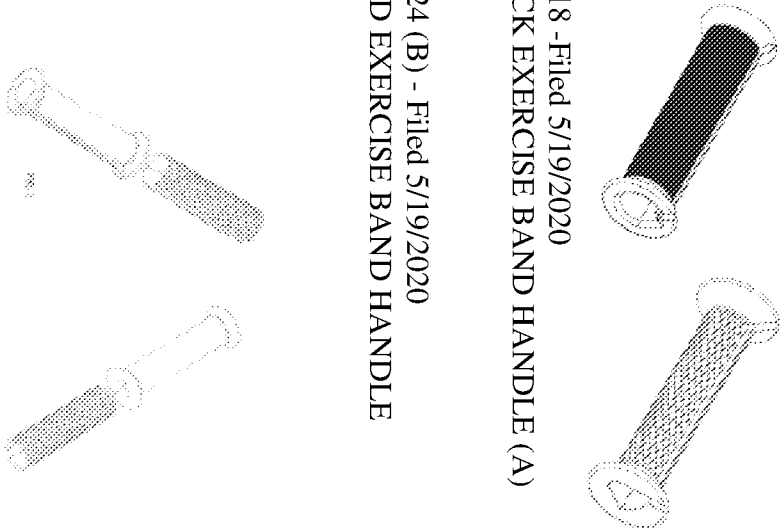

Application No. 29/747,915  
Filed 8/26/2020  
MOUNTABLE ANCHOR POINT  
Pending

**La Hague Design Registration**  
**Renewal: Feb. 25, 2026 – DM/216,124**  
**Up to 15 years in La Hague, then National**  
**Designations**

Canada: Expires Feb. 25, 2036 (15 years)  
EP: Expires Feb. 25, 2046 (25 years)  
UK: Expires Feb. 25, 2046 (25 years)  
Israel: Pending  
Japan: Expires Feb. 25, 2046 (25 years)  
Korea: Expires Feb. 25, 2041 (20 years)  
Russia: Expires Feb. 25, 2046 (25 years)  
Singapore: Expires Feb. 25, 2036 (15 years)  
Vietnam: Pending

Chinese Design Patent No.  
Filed February 25, 2021 / Pending  
Mexican Design Patent Application No  
MX/I/2021/000675  
Filed February 26, 2021 / Pending

App. No. 29/776,252  
Filed 3/29/2021  
EXERCISE BALL – Pending

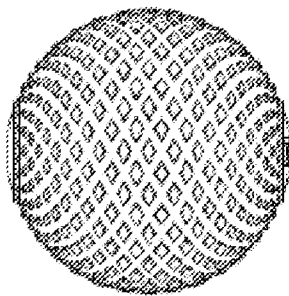

No International Designations

Patent No. D872200  
Filed 7/24/2019  
Resistance exercise band

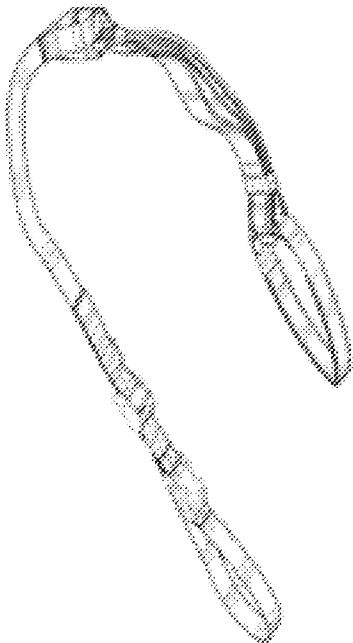

Patent No. ZL201430074906.9  
ADJUSTER  
Expires 4/2/2024

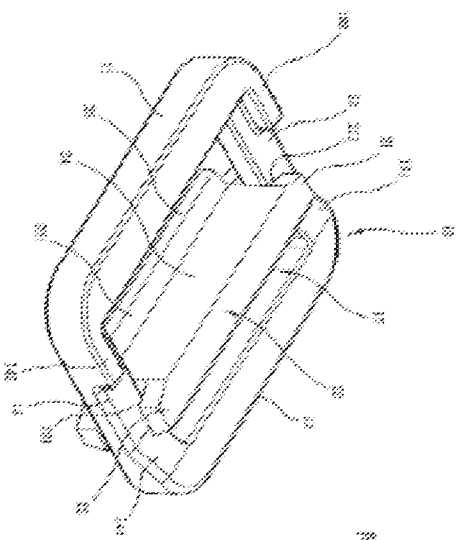

Schedule B  
Trademarks

Trademark	Country	App No./Reg. No.	Filing date/Reg.	Class(es)
<b>BANDIT</b>	United States	App. No. 90/078,548	7/28/2020	(028) Training equipment
	United States International Register	Reg. 1359822	5/1/2018 1/30/2017	(9) Digital materials (28) Training equipment (38) Streaming of videos (41) Fitness classes (9) Digital materials (28) Training equipment (38) Streaming of videos (41) Fitness classes
<b>DUO TRAINER</b>				
<b>FFT</b>	United States	Reg. 4,674,630	1/20/2015	(41) Fitness classes
	United States	Reg. 4,674,631	1/20/2015	(28) Training Equipment
<b>EXPEDITIONARY FUNCTIONAL TRAINING</b>	Australia	Reg. 942187	6/26/2007	(16) Instructional material (28) Training equipment
		Reg. 1374189	2/21/2011	(09) Digital materials
	Canada	Reg. TMA725248	10/3/2008	(28) Training equipment
	China	Reg. 8546102	4/14/2014	(41) Fitness classes
	Columbia	Reg. 441364	2/27/2012	(41) Fitness classes
		Reg. 441365	2/27/2012	(28) Training equipment
		Reg. 441366	2/27/2012	(09) Digital materials
	India	Reg. 1351410	5/2/2011	(09) Digital materials (28) Training equipment (41) Fitness classes
	Indonesia	Reg. DM000401302	7/22/2011	(41) Fitness classes
		Reg. DM000394677	8/19/2013	(28) Training equipment
		Reg. IDM000405248	1/20/2014	(09) Digital materials
	<b>FITNESS ANYWHERE</b>	Japan	Reg. 5422203	7/1/2011
Mexico		Reg. 1192428 Reg. Reg. 1209830	11/30/2010 6/14/3011 3/21/2011	(28) Training equipment (41) Fitness classes (09) Digital materials

Trademark	Country	App No./Reg. No.	Filing date/Reg.	Class(es)
	United States	Reg. 2,975,844	7/26/2005	(28) Training equipment
		Reg. No 4,103,996	2/28/2012	(09) Digital materials (38) Streaming of Videos (41) Fitness classes
FORCE TRAINING KIT	United States	Reg. 3,476,009	7/29/2008	(28) Training Equipment
GFT WITH THE MOVEMENT	United States	Reg. 3,922,984	2/22/2011	(41) Fitness classes
INVIZI-MOUNT	United States	Reg. 5,309,188	10/17/2017	(6) Hardware mounting systems
IRON CIRCUIT	Australia	Reg. 1374190	2/21/2011	(9) Digital Material
		Reg. 944907	8/6/2007	(16) Instructional Material (28) Training Equipment (41) Fitness Classes
	Canada	Reg. TMA715274	5/27/2008	(28) Training Equipment (41) Fitness Classes
	European Union	Reg. 944907	8/6/2007	(16) Instructional Material (28) Training Equipment (41) Fitness Classes
	Japan	Reg. 944907	8/6/2007	(16) Instructional Material (28) Training Equipment (41) Fitness Classes
	Japan	Reg. No. 5444122	10/14/2011	(9) Digital Material (41) Fitness Classes
MAKE YOUR BODY YOUR MACHINE	Korea	Reg. 40-0886119	10/20/2011	(9) Digital Material
		Reg. 1212533	4/1/2011	(9) Digital Material
		Reg. 1280116	4/18/2012	(41) Fitness Classes
		Reg. 1194629	12/15/2010	(28) Training equipment
		Reg. 1649801	6/30/2016	(28) Training equipment
		Reg. 827858	1/26/2011	(9) Digital Material
		Reg. 944907	8/6/2007	(16) Instructional Material (28) Training Equipment (41) Fitness Classes
	Singapore	Reg. 944907	8/6/2007	(16) Instructional Material (28) Training Equipment (41) Fitness Classes
	United Kingdom	Reg. UK00800944907	10/27/2008	(16) Instructional Material (28) Training Equipment (41) Fitness Classes



Trademark	Country	App No./Reg. No.	Filing date/Reg.	Class(es)	
	South Korea	Reg. 4008861190000	10/20/2011	(9) Digital Material	
		United States	Reg. 4,018,160	8/30/2011	(9) Digital Material
		Reg. 3,328,634	11/6/2007	(28) Training equipment	
MOVEMENT IS A VITAL SIGN	United States	Reg. No 3,463,278	7/8/2008	(41) Fitness Classes	
		Reg. 6,011,421	3/17/2020	(041) Physical education services	
		App. 6,322,902	4/13/2021	(025) Athletic Clothing	
RIP	Australia (WIPO)	Reg. 1532361	3/3/2022	(28) Training equipment	
	Brazil	Reg. 1532361	11/11/2021	(28) Training equipment	
	Canada	Reg. 1532361	11/11/2021	(28) Training equipment	
	China	Reg. 9889974	2/7/2014	(41) Fitness Classes	
	Reg. 989002	2/14/2014	(28) Training equipment		
RIP TRAINER	European Union	Reg. 010360618	8/9/2013	(09) Digital Material (28) Training Equipment (41) Fitness Classes	
	United States	Reg. No. 4,187,178	8/13/2018	(28) Training Equipment	
	United Kingdom	Reg. UK00910360592	10/27/2008	(28) Training Equipment	
	European Union	Reg. 010360592	8/9/2013	(28) Training equipment	
	Brazil	Reg. 831270276	1/21/2015	(41) Fitness Classes	
RIP TRAINING	China	Reg. 9890068	10/28/2012	(41) Fitness Classes	
	Reg. 9890070	10/28/2012	(09) Digital Material		
	European Union	Reg. 010360576	10/12/2013	(41) Fitness Classes	
	Brazil	Reg. 831270284	3/21/2017	(28) Training Equipment	
	China	Reg. 9889972	2/14/2014	(28) Training equipment	
SUSPENSION TRAINING	Argentina	Reg. 2600458	10/22/2013	(28) Training equipment	
		Reg. 2600457	10/22/2013	(41) Fitness Classes	
	Brazil	Reg. 830713077	4/26/2016	(09) Digital materials	
		Reg. 830713050	4/26/2016	(41) Fitness classes	
		Reg. 830713042	4/26/2016	(28) Training equipment	
	Canada	Reg. TMA72644	10/21/2008	(28) Training equipment (41) Fitness Classes	
	China	Reg. 930402	6/26/2007	(28) Training equipment (41) Fitness classes	
	Columbia	Reg. 441367	2/27/2012	(41) Fitness classes	
		Reg. 441368	2/27/2012	(09) Digital materials	
		Reg. 441372	2/27/2012	(28) Training equipment	
India	Reg. 1351410	5/2/2011	(9) Digital materials (28) Training		

Trademark	Country	App No./Reg. No.	Filing date/Reg.	Class(es)
TRX	Indonesia	Reg. ID/M000401438	7/22/2011	equipment (41) Fitness classes
		Reg. ID/M000387530	4/25/2013	(28) Training equipment
		Reg. ID/M000406679	2/10/2014	(09) Digital materials
	Japan	5422204	7/1/2011	(09) Digital materials (28) Training equipment (41) Fitness classes (44) Counseling Services for health management
	Malaysia	Reg. 2011000349	4/24/2013	(09) Digital materials
	Philippines	Reg. 04-2010-013991	7/7/2011	(28) Training equipment (41) Fitness classes
		Reg. 4-2010-013996	10/1/2011	(09) Digital materials
	Singapore	Reg. 930402	6/26/2007	(28) Training equipment (41) Fitness classes
	Thailand	Reg. SM54952	12/1/2010	(41) Fitness classes
		Reg. TM377423	12/1/2010	(28) Training equipment
	United States	Reg. 4.366.625	7/16/2013	(09) Digital materials
		Reg. 3.255.160	6/26/2007	(28) Training equipment
		Reg. 3.255.161	6/26/2007	(41) Fitness classes
		Reg. 2.795.383	4/13/2016	(28) Training equipment
	Argentina	Reg. 2.600.456	10/22/2013	(41) Fitness classes
Reg. 2.600.455		10/22/2013	(09) Digital materials	
Australia	Reg. 1374188	2/21/2011	(09) Digital materials	
	Reg. 939207	8/6/2007	(28) Training equipment (41) Fitness classes	
Brazil	Reg. 830713190	4/26/2016	(41) Fitness classes	
	App. 830713174	7/30/2010	(28) Training equipment	
	Reg. 830713131	4/26/2016	(09) Digital materials	
	Reg. 1533532	4/24/2020	(28) Training equipment	
Canada	Reg. TMA844,131	2/21/2013	(09) Training equipment	
	Reg. TMA726,445	10/21/2008	(28) Training equipment (41) Fitness classes	
	Reg. TMA957,662	12/9/2016	(25) Apparel	
Chile	Reg. 925787	7/22/2011	(9) Digital materials	
	Reg. 1164107	4/29/2015	(41) Fitness classes	
	Reg. 1048419	10/11/2013	(28) Training equipment	

Trademark	Country	App No./Reg. No.	Filing date/Reg.	Class(es)
	China	Reg. 8546097	8/14/2011	(9) Digital materials
		Reg. G939207	8/6/2017	(28) Training equipment (41) Fitness classes
	Colombia	Reg. 441373	2/27/2012	(9) Digital materials
		Reg. 441370	2/27/2012	(28) Training equipment
		Reg. 441369	2/27/2012	(41) Fitness classes
	European Union	Reg. 1204587	3/27/2014	Software as a service
		Reg. 939207	8/6/2007	(28) Training equipment (41) Fitness classes
	India	Reg. 1256717	2/12/2015	(25) Apparel
		Reg. 2138329	5/2/2011	(9) Digital materials (28) Training equipment (41) Fitness classes
	Indonesia	Reg. IDM000401439	7/22/2011	(41) Fitness classes
		Reg. IDM000387525	4/25/2013	(28) Training equipment
		Reg. IDM000405255	1/20/2014	(9) Digital materials
	Israel	Reg. No. 939207	8/6/2007	(28) Training equipment (41) Fitness classes
	Japan	Reg. 1067700	2/1/2011 (Int'l registration date); 1/27/2022 (Subsequent designation date)	(9) Digital materials, (28) Training equipment, (41) Fitness classes
			Examination pending	
		Reg. 2011000344	5/10/2013	(9) Digital materials
		Reg. 2011000345	1/7/2011	(28) Training equipment
		Reg. 2011000346	1/7/2011	(41) Fitness classes
	Mexico	Reg. 1209831	3/31/2011	(9) Digital materials
		Reg. 1214490	4/28/2011	(41) Fitness classes
		Reg. 1067700	PENDING	(28) Training equipment
		Reg. 827855	1/26/2011	(9) Digital Materials
	Norway	Reg. 1067700	2/1/2011	(9) Digital materials (28) Training equipment (41) Fitness classes
	South Korea	Reg. 1067700	PENDING	(9) Digital materials (28) Training equipment (41) Fitness classes
	Panama	Reg. 234204/01	8/14/2014	(9) Digital materials (28) Training equipment (38) Streaming of videos (41) Fitness classes

Trademark	Country	App No./Reg. No.	Filing date/Reg.	Class(es)
<b>TRX CERTIFIED</b> (Certified Mark)	United States	App. No. 90363512	12/7/2020	(B) Group or individual instruction and consultation in methods, techniques and procedures of training for developing physical strength and healthy lifestyles, exercise, conditioning, therapeutic exercises, fitness, corrective exercise programs
		Reg. UK00801204587	4/8/2015	(42) Software as a service
		Reg. UK00800939207		(28) Training equipment (41) Fitness classes
		Reg. P314985	2/17/2012	(9) Digital materials (28) Training equipment (41) Fitness classes
		Reg. P314984	2/17/2012	(28) Training equipment
		Reg. S050011	2/17/2012	(41) Fitness classes
		Reg. P314983	2/17/2012	(09) Digital materials
		Reg. 451159	6/23/2014	(28) Training equipment
		Reg. 4,542,811	6/3/2014	(42) Software as a service
		Reg. 4,998,892	7/12/2016	(25) Apparel
		Reg. 4,731,160	5/5/2015	(25) Apparel
		Reg. 3,202,696	1/23/2007	Fitness classes
Reg. 3,384,871	2/19/2008	(41) Fitness classes		
Reg. 4,018,159	8/30/2011	(9) Digital materials (38) Streaming of videos (41) Fitness classes		
Reg. No. 1067700	2/21/2011	(9) Digital materials (28) Training equipment (41) Fitness classes		
Reg. No. 1067700	2/20/2017	(9) Digital materials (16) Instruction handbooks		
Reg. 1067700	2/1/2011	(9) Digital materials (28) Training equipment (41) Fitness classes		
Reg. 1067700	2/29/2012	(41) Fitness classes		
Reg. 450038730	4/8/2020	(9) Digital materials (28) Training equipment (41) Fitness classes		
Reg. 1067700	2/1/2011	(9) Digital materials (28) Training equipment (41) Fitness classes		
Reg. 939207	8/6/2009	(28) Training equipment (41) Fitness classes		
Reg. No. 1067700	2/1/2011	(9) Digital materials (28) Training equipment (41) Fitness classes		
Reg. No. 1067700	2/29/2012	(41) Fitness classes		
Reg. 450038730	4/8/2020	(9) Digital materials (28) Training equipment (41) Fitness classes		
Reg. 1067700	2/1/2011	(9) Digital materials (28) Training equipment (41) Fitness classes		
Reg. 01894183	2/20/2017	(9) Digital materials (16) Instruction handbooks		
Reg. No. 1067700	2/21/2011	(9) Digital materials (28) Training equipment (41) Fitness classes		
Reg. 4,018,159	8/30/2011	(9) Digital materials (38) Streaming of videos (41) Fitness classes		
Reg. 3,384,871	2/19/2008	(41) Fitness classes		
Reg. 3,202,696	1/23/2007	Fitness classes		
Reg. 4,731,160	5/5/2015	(25) Apparel		
Reg. 4,998,892	7/12/2016	(25) Apparel		
Reg. 4,542,811	6/3/2014	(42) Software as a service		
Reg. 451159	6/23/2014	(28) Training equipment		
Reg. P314983	2/17/2012	(09) Digital materials		
Reg. S050011	2/17/2012	(41) Fitness classes		
Reg. P314984	2/17/2012	(28) Training equipment		
Reg. P314985	2/17/2012	(9) Digital materials		
Reg. UK00801256717	5/25/2016	(25) Apparel		
Reg. UK00801204587	4/8/2015	(42) Software as a service		
Reg. UK00800939207		(28) Training equipment (41) Fitness classes		

Trademark	Country	App No./Reg. No.	Filing date/Reg.	Class(es)
				all in relation with strap-based training equipment.
TRX CORE	United States	Reg. No. 4,422,454	10/2/2013	(41) Fitness classes
TRX FORCE	United States	Reg. No. 4,027,129	9/13/2011	(28) Training equipment
TRX LIVE	United States	App. No. 90360346	12/4/2020	(38) Streaming of videos (41) Fitness classes
TRX M BODY STRAP INTO THE MOVEMENT	United States	Reg. No. 6,139,690	9/1/2020	(41) Fitness classes
 <b>STRAP MAKE YOUR BODY YOUR MACHINE</b>	United States	Reg. No. 4,583,899	8/12/2014	(28) Training equipment
	Mexico	Reg. No. 1193224	1/2/2014	(28) Training equipment
<b>TRX ROCKER</b>	United States	Reg. No. 6,049,742	5/5/2020	(28) Training Equipment
	Australia (Granted)	Reg. 1523837	2/28/2020	(28) Training Equipment
	Brazil	Reg. 1523837	2/28/2020	(28) Training Equipment
	Canada	Reg. 1523837	2/28/2020	(28) Training Equipment
	China (Granted)	Reg. 1523837	2/28/2020	(28) Training Equipment
	European Union (Granted)	Reg. 1523837	2/28/2020	(28) Training Equipment
	India (Granted)	Reg. 1523837	2/28/2020	(28) Training Equipment
	Japan	Reg. 1523837	2/28/2020	(28) Training Equipment
	Mexico	Reg. 1523837	2/28/2020	(28) Training Equipment
	Singapore (Granted)	Reg. 1523837	2/28/2020	(28) Training Equipment
	Turkey	Reg. 1523837	2/28/2020	(28) Training Equipment
	European Union	Reg. 10360543	3/1/2012	(41) Fitness classes
<b>TRX TEAM</b>	United States	Reg. No. 4,129,135	4/17/2012	(41) Fitness classes
	Canada	Reg. No. TMA811954	11/17/2011	(41) Fitness classes
	United Kingdom	Reg. UK00801523837	9/1/2020	(28) Training Equipment
	Australia	Reg. 1455248	7/9/2012	(41) Fitness classes
	New Zealand	Reg. 851227	8/28/2012	(41) Fitness classes
<b>TRX TRAINING CENTER</b>	United States	Reg. No. 4,129,135	4/17/2012	(41) Fitness classes
	United States	Reg. No. 3,925,283	3/1/2011	(41) Fitness classes

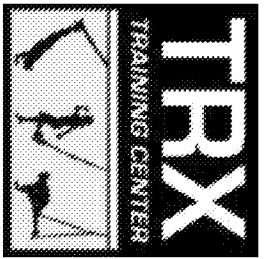

Trademark	Country	App No./Reg. No.	Filing date/Reg.	Class(es)
<b>TRX TRAINING CENTER</b> <b>TRX TRAINING CLUB</b> <b>TRX TRAINING ZONE</b> <b>VECTOR RESISTANCE</b>	United States	Reg. No. 4,345,798	6/4/2013	(41) Fitness classes
	United States	App. 90/593,456	3/22/2021	(38) Streaming of videos (41) Fitness classes
	United States	Reg. No. 4,459,672	12/31/2013	(06) Hardware mounting system for use with exercise training equipment
	United States	Reg. No. 2,953,907	5/1/2005	(28) Training Equipment
	Australia	Reg. 930088	7/1/2007	(28) Training equipment
		Reg. 930271	7/1/2007	(41) Fitness Classes
	Brazil	Reg. 830712976	4/26/2016	(28) Training equipment
		Reg. 830712852	4/26/2016	(09) Digital Material
	Canada	Reg. TMA724935	10/1/2008	(28) Training Equipment
		Reg. 8546348	8/14/2011	(09) Digital Material
	China	Reg. G930088	7/1/2007	(28) Training equipment
		Reg. G930271	7/1/2007	(41) Fitness Classes
European Union	Reg. 930088	7/1/2007	(28) Training equipment	
	Reg. 930271	7/1/2007	(41) Fitness Classes	
Japan	Reg. 930088	7/1/2007	(28) Training equipment	
	Reg. 930271	7/1/2007	(41) Fitness Classes	
Singapore	Reg. 930271	7/1/2007	(41) Fitness Classes	
	Reg. 930088	7/1/2007	(28) Training equipment	
South Korea	Reg. 40-0886122	10/20/2011	(28) Training equipment	
	Reg. 930088	7/1/2007	(28) Training equipment	
United Kingdom	Reg. UK00800930088	6/30/2008	(28) Training equipment	
	Reg. UK00800930271	6/20/2008	(41) Fitness Classes	
Mexico	Reg. 1209832	3/31/2011	(09) Digital Training equipment	
	Reg. 1184390	10/15/2010	(28) Training equipment	
	Reg. 1224666	6.27.2011	(41) Fitness Classes	

X

Trademark	Country	App No./Reg. No.	Filing date/Reg.	Class(es)
	United States	Reg. 4,011,271	8/16/2011	(09) Digital Material
<b>XMOUNT</b>	United States	Reg. 3,329,136 Reg. No. 4,125,533	11/6/2007 4/10/2012	(41) Fitness Classes (06) Hardware mounting system for use with exercise training equipment
	United States	Reg. No. 4,741,049	5/19/2015	(28) Training equipment

Schedule C  
Copyright Registrations

#	Name	Full Title	Copyright Number	Date
[1]	Fitness Anywhere, LLC	<u>All Body Xpress Volume 1.</u>	PA0001648104	2007
[2]	Fitness Anywhere, LLC	<u>All Body Xpress Workout Guide.</u>	VA0001692428	2007
[3]	Fitness Anywhere, LLC	<u>Military fitness guide: TRX suspension training.</u>	TX0006446728	2006
[4]	Fitness Anywhere, LLC	<u>TRX all body workout.</u>	VA0001326158	2005
[5]	Fitness Anywhere, LLC	<u>TRX Basic Training.</u>	PA0001727874	2009
[6]	Fitness Anywhere, LLC	<u>TRX Basic Training.</u>	VA0001755968	2009
[7]	Fitness Anywhere, LLC	<u>TRX Basic Training Quick Start &amp; Workout Guide.</u>	TX0007252143	2009
[8]	Fitness Anywhere, LLC	<u>TRX Boot Camp: Ropes &amp; Straps.</u>	PA0001628051	2009
[9]	Fitness Anywhere, LLC	<u>TRX Boot Camp: Ropes &amp; Straps Workout Guide.</u>	VA0001747882	2009
[10]	Fitness Anywhere, LLC	<u>TRX core strength : vol. 1.</u>	PA0001381425	2006
[11]	Fitness Anywhere, LLC	<u>TRX core strength : vol. 1.</u>	VA0001403391	2006



[12]	Fitness Anywhere, LLC	<u>TRX Essentials: Cardio Circuit.</u>	PA0001626892	2009
[13]	Fitness Anywhere, LLC	<u>TRX Essentials: Cardio Circuit Workout Guide.</u>	VA0001747884	2009
[14]	Fitness Anywhere, LLC	<u>TRX Flexibility.</u>	VA0001664325	2008
[15]	Fitness Anywhere, LLC	<u>TRX Force Field Guide.</u>	VA0001743941	2010
[16]	Fitness Anywhere, LLC	<u>TRX Force Trainer Course.</u>	TX0007275006	2010
[17]	Fitness Anywhere, LLC	<u>TRX Force Trainer Course User's Guide.</u>	TX0007268893	2010
[18]	Fitness Anywhere, LLC	<u>TRX Performance: Team Sports.</u>	PA0001622895	2008
[19]	Fitness Anywhere, LLC	<u>TRX Performance: Train Like The Pros.</u>	PA0001623374	2008
[20]	Fitness Anywhere, LLC	<u>TRX Pilates series.</u>	VA0001326157	2005
[21]	Fitness Anywhere, LLC	<u>TRX Strength.</u>	VA0001664327	2008
[22]	Fitness Anywhere, LLC	<u>TRX Strength Advanced.</u>	VA0001664323	2008
[23]	Fitness Anywhere, LLC	<u>TRX Suspension Training Course.</u>	TX0007267550	2008
[24]	Fitness Anywhere, LLC	<u>TRX Suspension Training Group Course.</u>	PA0001753512	2008
[25]	Fitness Anywhere, LLC	<u>TRX Professional System.</u>	VA0001423942	2006

[26]	Fitness Anywhere, LLC	<u>TRX Team Coach Playbook.</u>	TX0007257144	2010
[27]	Fitness Anywhere, LLC	<u>RIP TRAINING Leaner Faster Stronger.</u>	TX0007886434	2013
[28]	Fitness Anywhere LLC	<u>TRX All Body Workout Function Strength Control.</u>	VA0001787364	2005
[29]	Fitness Anywhere LLC	<u>TRX Boot Camp Ropes &amp; Straps Round 2.</u>	VA0001817406	2009
[30]	Fitness Anywhere LLC	<u>TRX Boot Camp Ropes &amp; Straps Round 2.</u>	VA0001780730	2009
[31]	Fitness Anywhere LLC	<u>TRX Boot Camp Ropes &amp; Straps Round 2.</u>	TX0007393092	2009
[32]	Fitness Anywhere LLC	<u>TRX Education Trainer Basics.</u>	VA0001779639	2007
[33]	Fitness Anywhere LLC	<u>TRX Essentials Flexibility.</u>	TX0007402378	2010
[34]	Fitness Anywhere LLC	<u>TRX Essentials Flexibility.</u>	VA0001817574	2008
[35]	Fitness Anywhere LLC	<u>TRX Essentials Flexibility.</u>	VA0001783409	2008
[36]	Fitness Anywhere LLC	<u>TRX Essentials Strength.</u>	VA0001817599	2008
[37]	Fitness Anywhere LLC	<u>TRX Essentials Strength.</u>	TX0007395670	2008
[38]	Fitness Anywhere LLC	<u>TRX Essentials Strength.</u>	VA0001779525	2008

[39]	Fitness Anywhere LLC	<u>TRX Female Silhouette actual work et al.</u>	VA0001858853	2012
[40]	Fitness Anywhere LLC	<u>TRX Flexibility.</u>	VA0001796892	2008
[41]	Fitness Anywhere LLC	<u>TRX Force.</u>	VA0001819177	2008
[42]	Fitness Anywhere LLC	<u>TRX Force.</u>	VA0001780717	2008
[43]	Fitness Anywhere LLC	<u>TRX Force Field Guide.</u>	TX0007394610	2010
[44]	Fitness Anywhere LLC	<u>TRX Gel Started Set Up Activate Workout.</u>	TX0007695173	2012
[45]	Fitness Anywhere LLC	<u>TRX Golf Workout.</u>	VA0001787389	2007
[46]	Fitness Anywhere LLC	<u>TRX Golf Workout.</u>	PA0001764162	2007
[47]	Fitness Anywhere LLC	<u>TRX Home Gym Product Package Image (1015)</u>	VA0001995042	2015
[48]	Fitness Anywhere LLC	<u>TRX Home Male Silhouette.</u>	VA0001858946	2012
[49]	Fitness Anywhere LLC	<u>TRX Home Package Design.</u>	VA0001858938	2012
[50]	Fitness Anywhere LLC	<u>TRX Kettlebell Iron Circuit Conditioning.</u>	VA0001819176	2010
[51]	Fitness Anywhere LLC	<u>TRX Kettlebell Iron Circuit Conditioning.</u>	TX0007393088	2010
[52]	Fitness Anywhere LLC	<u>TRX Kettlebell Iron Circuit Conditioning.</u>	VA0001781673	2010
[53]	Fitness Anywhere LLC	<u>TRX Performance:</u>	VA0001817392	2008

		<u>Tennis.</u>		
[54]	Fitness Anywhere LLC	<u>TRX</u> Performance: <u>Tennis.</u>	TX0007387297	2008
[55]	Fitness Anywhere LLC	<u>TRX</u> Performance: <u>Tennis.</u>	VA0001779637	2008
[56]	Fitness Anywhere LLC	<u>TRX</u> Pilates Series <u>Function</u> <u>Strength</u> <u>Control.</u>	VA0001787204	2005
[57]	Fitness Anywhere LLC	<u>TRX</u> Pro Package <u>Design.</u>	VA0001858949	2012
[58]	Fitness Anywhere LLC	<u>TRX</u> Rip Trainer: Basic <u>Training.</u>	PA0001789490	2011
[59]	Fitness Anywhere LLC	<u>TRX</u> Rip Trainer: Basic <u>Training.</u>	VA0001781491	2011
[60]	Fitness Anywhere LLC	<u>TRX</u> Rip Trainer: Basic <u>Training.</u>	TX0007390962	2011
[61]	Fitness Anywhere, LLC	<u>TRX SETUP &amp; USE.</u>	PA0001891599	2013
[62]	Fitness Anywhere LLC	<u>TRX Strength.</u>	VA0001793260	2009
[63]	Fitness Anywhere LLC	<u>TRX Strength Advanced.</u>	VA0001787624	2009
[64]	Fitness Anywhere LLC	<u>TRX</u> Suspension <u>Training</u> <u>Sports</u> <u>Medicine: User's Guide.</u>	TX0007376286	2010
[65]	Fitness Anywhere LLC	<u>TRX</u> Team Coach <u>Workbook.</u>	TX0007393116	2010

[66]	Fitness Anywhere LLC	<u>TRX Team Rollout Manual.</u>	TX0007396873	2010
[67]	Fitness Anywhere LLC	<u>TRX TEAM Training Camp Play Cards.</u>	TX0007546105	2010
[68]	Fitness Anywhere LLC	TRX suspension training group course user guide.	V3601D492	2011
[69]	Fitness Anywhere LLC	TRX force operator course	V3601D492	2011
[70]	Fitness Anywhere LLC	TRX suspension training course leader's guide.	V3601D492	2011
[71]	Fitness Anywhere LLC	TRX suspension training course leader's guide.	V3601D492	2011
[72]	Fitness Anywhere LLC	TRX suspension training group course.	V3601D492	2011
[73]	Fitness Anywhere LLC	TRX suspension training course.	V3601D492	2011
[74]	Fitness Anywhere LLC	TRX basic training	V3601D492	2011

Schedule D

Domain Names

**Domain Name**

1trx.com  
2trx.com  
4evertrx.com  
90daytrx.com  
abouttrx.com  
abstrx.com  
airforectrx.com  
alldbodyexpress.com  
alldbodyxpress.com  
alltrx.com  
alltrxallthetime.com  
armytrx.com  
asiapacifictrx.com  
athletestrx.com  
besttotalbodytool.com  
besttrx.com  
besttrxsale.com  
besttrxsales.info  
besttrxstore.com  
besttrxstore.info  
besttrxstore.net  
besttrxstore.org  
besttrxstoreblog.info  
besttrxtraining.info  
besttrxworkout.info  
bitztrx.com  
body-weightstraps.com  
bodyconterge.com  
bodyleverage.org  
bodyweight-trainer.com  
bodyweight-training.com  
bodyweightleverage.com  
bodyweightonly.biz  
bodyweightonly.com  
bodyweightonly.org  
bodyweightonly.tv  
bodyweightresistance.com  
bodyweightresistancestraps.com  
bodyweightresistancetrainer.com  
bodyweightresistancectrx.com  
bodyweightstraps.com  
bodyweightstraps.com  
bodyweightsuspension.com  
bodyweightsuspensiontraining.com  
bodyweighttrain.com

bodyweighttrainer.com  
bodyweighttraining.biz  
bodyweighttraining.net  
bodyweighttraining.tv  
boxingstraps.com  
busanovement.com  
buycheaptrx.com  
buycheaptrx.info  
buycheaptrx.net  
buycheaptrx.org  
buycheaptrxblog.info  
buydiscounttrx.com  
buygenuinetrx.com  
buygenuinetrxproducts.com  
buysuspensiontrainer.com  
buysuspensiontraining.com  
buytrx.biz  
buytrx.us  
buytrxbundles.com  
buytrxproducts.com  
buytrxpropack.biz  
buytrxpropack.us  
buytrxsuspension.info  
buytrxsuspensiontrainer.com  
buytrxteam.com  
buytrxtraining.info  
californiatraining.com  
captantrx.com  
cheaptrx.co  
cheaptrx.info  
cheaptrx.net  
cheaptrx.org  
cheaptrx.us  
cheaptrxforsale.info  
cheaptrxonline.info  
cheaptrxsale.info  
cheaptrxshop.com  
cheaptrxstore.com  
cheaptrxsuspension.com  
cheaptrxtraining.com  
cheaptrxtraining.info  
chinatraining.com  
coachtrx.com  
coastguardtrx.com  
communitytrx.com  
core-centric.com  
counterfeittrx.com  
coursestrx.com  
crazytrx.com  
demoatraining.com  
discounttrx.com  
donorbuytrx.com  
doyoutrx.com  
educationtrx.com

famevisuals.com  
famevisuals.me  
famevisuals.mobi  
famevisuals.net  
famevisuals.org  
famevisuals.tv  
fandrx.com  
findcheaptrx.info  
findrxsale.info  
findrxstore.info  
finessanyplace.com  
finessanywhere.biz  
finessanywhere.ca  
finessanywhere.com  
finessanywhere.info  
finessanywhere.mobi  
finessanywhere.net  
finessanywhere.tv  
finessanywhere.us  
finessanywherebrasil.com  
finessanywheredistributor.com  
finessanywheredistributors.com  
finessanywheremerchandise.com  
finessanywhereonline.com  
finessanywhereonlinestore.com  
finessanywhereshop.com  
finessanywhereshop.info  
finessanywheresucks.com  
finessanywhereusa.com  
finessanywhere.info  
finessanywhere.mobi  
finessanywhere.org  
finessanywhere.tv  
finessanywhereonline.com  
finessinabag.com  
finessstrainingtrx.com  
fitontheFly.com  
flextrx.com  
forcetrainingkit.com  
forcetrnx.com  
freetrnx.biz  
freetrnx.co  
freetrnx.com  
freetrnx.info  
freetrnx.net  
freetrnx.org  
freetrnx.us  
freetrnxblog.info  
freetrnxbootcamp.com  
freetrnxcoupon.info  
freetrnxkettlebell.com  
freetrnxshop.info  
freetrnxstore.info  
freetrnxtraining.info  
fullactionSuspensiontraining.com



fullactionssuspensiontraining.net  
fullactionssuspensiontraining.org  
functionalandfuntraining.com  
functionalfitnessrx.com  
functionalspot.com  
functionaltraining.com  
functionalrx.com  
funtrx.com  
genuinetrx.com  
get-with-the-movement.com  
getatrx.com  
getmovingwithrx.com  
getsuspended.com  
getwiththemovement.com  
getwithtrainingzone.com  
getyourrx.com  
gravytraining.org  
gsc-trx.com  
gstc.com  
hangouttraining.com  
hardcoretrx.com  
homeofsuspensiontraining.com  
homeofhertrx.com  
hometrainingrx.com  
ilovebodyweighttraining.com  
ilovesuspensiontraining.com  
ilovetrx.com  
integraltrainingrx.com  
integraltraining.com  
internetrxbuying.com  
ironforcetrx.com  
ironrx.com  
iusetrx.com  
joinbecore.com  
jointrxteam.com  
justrx.com  
kettlebellrx.com  
kettlepack.com  
kettleruck.com  
lifefunction.com  
lifetrx.com  
lovetrx.com  
makeyourbodyyourmachine.com  
makeyourbodyyourmachineshop.com  
makeyourbodyyourmachinesore.com  
marinesrx.com  
medicalrx.com  
militaryfitnessguide.com  
militaryforceexercise.com  
militaryrx.com  
mlbstraps.com  
mmaststraps.com  
mmasuspensionstraps.com  
mobiextrx.info  
moblietrx.org

modetrx.com  
movementrx.com  
musclesandfitnessrx.com  
mycheaptx.info  
mysuspensionyoga.com  
mytrxfitness.com  
mytrxforeckit.info  
mytrxxkettlebell.com  
mytrxpro.info  
mytrxprograms.com  
myrxpropack.com  
myrxshop.com  
myrxshop.info  
myrxstore.info  
myrxsucks.biz  
myrxsucks.com  
myrxsucks.info  
myrxsucks.us  
myrxsucksblog.info  
myrxsucksnow.info  
myrxsucksonline.info  
myrxsucksshop.info  
myrxsucksstore.info  
myrxsucksstore.info  
myrxsuckstoday.info  
myrxsuspensiontraining.com  
myrxtrainer.com  
myrxtraining.com  
myrxtraining.info  
myrxtrainingpro.com  
myrxtrainingsstore.co  
myrxtrainingsstore.com  
myrxtrainingsstore.info  
myrxtrainingsstore.net  
myrxtrainingstore.org  
myrxworkouts.com  
myrxyoga.com  
navysealstraps.com  
navysealsuspensiontraining.com  
navysealtrx.com  
nbstraps.com  
newtrx.com  
newtrxfitness.us  
newtrxpro.info  
newtrxtraining.info  
nhlstraps.com  
nomotorfreeeweights.com  
noseriouslythisistheraltrx.com  
oaklandtrx.com  
officialaltrx.com  
officialaltrx.com  
ohlnetrxshop.com  
onlouttrx.com  
orderingtrx.com  
pectationstrx.com

professionaleducationtrx.com  
programmimgtrx.com  
propacktrx.com  
randyhetricksocks.com  
rede-finedtrx.com  
rehabilitationtrx.com  
rehabtrx.com  
resistancestraps.com  
rip-corefx.com  
rip-corefx.net  
rip-fitness.com  
rip-fitness.net  
rip-trainer.com  
rip-training.com  
rip-training  
ripcorefx.com  
ripcorefx.net  
riptrainer.com  
saleontrx.com  
saleontrx.info  
saleontrx.net  
saleontrx.org  
saleontrxblog.info  
sanfranciscotrx.com  
sealstraps.com  
sealtrx.com  
shopdiscountrx.com  
shopgenuinetrx.com  
shopmilitarytrx.com  
shoppingtrx.com  
shopsuspensiontrainer.com  
shoptrx.com  
shoptrx.net  
shoptrx.org  
shoptrxbundles.com  
shoptrxforekit.com  
shoptrxpopack.com  
shoptrxframes.com  
shoptrxsuspensiontrainer.com  
shoptrxteam.com  
slingfit.com  
slingfit.net  
slingfit.org  
slingfitness.net  
slingfitness.org  
slingtraining.com  
slingtraining.info  
slingtraining.net  
sportsmedicinetrx.com  
sporttrx.com  
stc-trx.com  
stctrx.com  
straighttrx.com  
strapfit.com  
strapfit.net

strapfit.org  
strapfitness.com  
strapfitness.net  
strapfitness.org  
straptraining.com  
straptraining.net  
straptraining.org  
strongrx.com  
studdlortx.com  
suspenddtrx.com  
suspendlimits.com  
suspendyourlimits.com  
suspendyourself.com  
suspension-studio.com  
suspension-studios.com  
suspension-trainer.com  
suspension-training.com  
suspension-workout.com  
suspension.training  
suspensionathlete.com  
suspensionathletics.com  
suspensionbased.com  
suspensionfit.com  
suspensionfitness.com  
suspensionfitnesstraining.com  
suspensionlab.com  
suspensionloft.com  
suspensionplates.com  
suspensionstrap.org  
suspensionstraps.com  
suspensionstudio.com  
suspensionstudios.com  
suspensiontrainer.biz  
suspensiontrainer.com  
suspensiontrainer.info  
suspensiontrainer.net  
suspensiontrainer.org  
suspensiontrainer.us  
suspensiontrainers.com  
suspensiontrainers.net  
suspensiontrainers.org  
suspensiontrainershop.com  
suspensiontrainersstore.com  
suspensiontrainerwebstore.com  
suspensiontraining.biz  
suspensiontraining.com  
suspensiontraining.info  
suspensiontraining.net  
suspensiontraining.org  
suspensiontraining.us  
suspensiontraininganywhere.com  
suspensiontrainingbodyweightexercise.com  
suspensiontrainingcourse.com  
suspensiontrainingeducation.com

suspensiontraininghome.com  
suspensiontraininglab.com  
suspensiontrainingmerch.com  
suspensiontrainingshop.com  
suspensiontrainingstore.com  
suspensiontrainingstraps.com  
suspensiontrainingstudio.com  
suspensiontrainingstudios.com  
suspensiontrainingtrx.com  
suspensiontrainingusa.com  
suspensiontrainingzone.com  
suspensiontrainwithtrx.com  
suspensiontraining.com  
suspensionworkout.com  
suspensionworkouts.com  
suspensionyoga.mobi  
suspensionyoga.net  
suspensionyoga.tv  
suspensionyogaonline.com  
tacticaltrx.com  
tacticaltrxtraining.com  
teamecaptaintrx.com  
teamecoachtrx.com  
thebodyisyourmachine.com  
thefitnesseverywhere.com  
thegeninetrx.com  
therealdealtrx.com  
therealtrx.com  
therxbootcamp.com  
therxfitness.com  
therxforcekit.info  
therxkettlebell.com  
therxmovement.com  
therxplates.com  
therxpro.info  
therxpropack.com  
therxshop.com  
therxshop.net  
therxshop.org  
therxstore.com  
therxsuspensiontraining.com  
therxtrainer.com  
therxtrainingpro.com  
therxworkout.info  
therxworkouts.com  
therxyoga.com  
totalbodystrength.com  
totalresistanceexercise.com  
totalresistancestraps.com  
totalresistancetraining.com  
totalresistanceexercise.com  
trainanywherewithtrx.com  
trainingcamptrx.com  
trainingcentertrx.com

trainingstraps.com  
trainthekedrew.com  
trainontrx.com  
traintrxteam.com  
trainwithfraser.com  
trainwithnatale.com  
trainwithrandy.com  
trainwithsuspension.com  
travelfit.com  
trx-baseball.com  
trx-bootcamp.com  
trx-core.com  
trx-education.com  
trx-europe.com  
trx-fitnessanywhere.com  
trx-fitnessanywhere.net  
trx-football.com  
trx-gstc.com  
trx-kettlebell.com  
trx-lifestyle.com  
trx-hive.com  
trx-mobile.com  
trx-mobile.info  
trx-mobile.net  
trx-mobile.org  
trx-ondemand.com  
trx-ppopack.com  
trx-running.com  
trx-shop.com  
trx-snowboarding.com  
trx-soccer.com  
trx-stc.com  
trx-suspension-trainer.com  
trx-suspension-training.com  
trx-trainer.com  
trx-training.com  
trx-trainingclub.com  
trx-trainingzone.com  
trx-virtualpersonaltraining.com  
trx-vpl.com  
trx-workouts.com  
trx-zone.com  
trx.co.uk  
trx.fit  
trx.training  
trx.uk  
trx101.com  
trx4ever.com  
trx4sale.com  
trxabs.com  
trxaction.com  
trxadvanced.com  
trxairforce.com  
trxambassador.com

trxamerica.com  
trxandyou.com  
trxarmy.com  
trxsipacific.com  
trxathletes.com  
trxathletics.com  
trxathome.com  
trxaustralia.com.au  
trxbalance.com  
trxband.com  
trxbands.info  
trxbargins.com  
trxbenefits.com  
trxbesideal.com  
trxbesideal.info  
trxbesideal.net  
trxbesideal.org  
trxbesidealonline.info  
trxblackandyellow.com  
trxblast.com  
trxblitz.com  
trxblog.co  
trxblog.com  
trxblog.net  
trxblog.org  
trxblowout.com  
trxblows.com  
trxbody.biz  
trxbody.co  
trxbody.info  
trxbody.net  
trxbody.org  
trxbody.us  
trxbodytraining.com  
trxbodyweb.com  
trxbodyweightexercise.com  
trxbotcampcentral.com  
trxbotcamponline.com  
trxbrasil.com  
trxbrazil.com  
trxbuilt.com  
trxbundle.com  
trxbundles.com  
trxbuy.com  
trxbuy.info  
trxbuy.net  
trxbuy.org  
trxbuying.com  
trxbuying.net  
trxbuying.org  
trxbuyingsite.info  
trxbuynow.info  
trxbuyzone.com  
trxcaptain.com  
trxcenter.com

trxcenter.info  
trxcntral.com  
trxcertificate.com  
trxcheapsale.com  
trxcheck.com  
trxchina.com  
trxclng.com  
trxclass.com  
trxclassfinder.com  
trxcloseout.com  
trxclubs.com  
trxcoach.com  
trxcoastguard.com  
trxcommunity.com  
trxcondition.com  
trxcore.com  
trxcostrength.com  
trxcotraining.com  
trxcoupon.biz  
trxcoupon.co  
trxcoupon.com  
trxcoupon.info  
trxcoupon.net  
trxcoupon.org  
trxcoupon.us  
trxcouponblog.info  
trxcoupons.info  
trxcouponshop.info  
trxcouponsite.info  
trxcouponstore.info  
trxcoupontoday.info  
trxcourses.com  
trxcrazy.com  
trxcday.com  
trxcdel.biz  
trxcdel.co  
trxcdel.com  
trxcdel.info  
trxcdel.net  
trxcdel.org  
trxcdel.us  
trxcdvelop.com  
trxcdirectory.com  
trxcdiscount.com  
trxcdiscount.info  
trxcdiscount4you.com  
trxcdiscounnow.info  
trxcdiscounshop.info  
trxcdiscounstore.info  
trxcdiscountoday.info  
trxdomestic.com  
trxdrive.com  
trxdvds.com  
trxcommerce.com  
trxeducate.com



trxeducation.com  
trxeminentamiento.com  
trxequipment.com  
trrxers.com  
trxessential.com  
trxessentials.com  
trxexercises.com  
trxfactor.com  
trxfan.com  
trxfaloss.com  
trxfilms.com  
trxfitorlife.com  
trxfitness-shop.com  
trxfitness-shop.info  
trxfitness-shops.info  
trxfitness.com  
trxfitness.info  
trxfitnessanywhere.com  
trxfitnessanywhere.ca  
trxfitnessanywhere.com  
trxfitnessanywhere.info  
trxfitnesscenter.com  
trxfitnessequipment.com  
trxfitnessmovement.com  
trxfitnessonline.com  
trxfitnessshop.com  
trxfitnessshop.info  
trxfitnessusa.com  
trxfitnessworld.com  
trxfotball.com  
trxforce.com  
trxforce.info  
trxforcekit.com  
trxforcesshop.biz  
trxforcesshop.com  
trxforcesshop.us  
trxforcetraining.com  
trxforever.com  
trxforlife.com  
trxforsale.info  
trxfoundation.com  
trxfoundation.net  
trxfoundation.org  
trxfun.com  
trxfunfitness.com  
trxfunfunctionaltraining.com  
trxfunworkout.com  
trxgear.com  
trxgearshop.com  
trxgifts.com  
trxgroupfitness.com  
trxgym.com  
trxgym.info  
trxgyms.com  
trxhardcore.com

trxheadquarters.com  
trxhealth.com  
trxhome.com  
trxidea.com  
trxmaction.com  
trxindia.com  
trxing.com  
trxinstruction.com  
trxintegratraltraining.com  
trxiron.com  
trxironcircuit.com  
trxironcircuit.net  
trxironcircuit.org  
trxironforce.com  
trxisawesome.com  
trxitaly.com  
trxjourney.com  
trxkettlebellcentral.com  
trxkettlebellonline.com  
trxknockoff.com  
trxknockoffs.com  
trxlactosse.com  
trxlactosse.info  
trxlactosse.net  
trxlactosse.org  
trxlactosse.us  
trxlax.com  
trxlax.info  
trxlax.net  
trxlax.org  
trxlax.us  
trxleader.com  
trxlearn.com  
trxlife.com  
trxlocations.com  
trxlocator.com  
trxlove.com  
trxmaps.com  
trxmaps.info  
trxmarines.com  
trxmarket.info  
trxme.com  
trxmedical.com  
trxmedicine.com  
trxmERCHANTISE.com  
trxmERCHSHOP.com  
trxmilitary.com  
trxmma.com  
trxmnaonline.com  
trxmobi.net  
trxmobil.com  
trxmobil.info  
trxmobil.org  
trxmobil.com  
trxmobil.info

trxmoble.net  
trxmoble.org  
trxmove.com  
trxmovement.com  
trxmovement.net  
trxmovement.org  
trxmovementonline.com  
trxmuscledesign.com  
trxmuscledesignfitness.com  
trxnavy.com  
trxnavyseal.com  
trxnov.com  
trxofter.biz  
trxofter.co  
trxofter.com  
trxofter.net  
trxofter.org  
trxonlinestore.com  
trxonsale.biz  
trxonsale.co  
trxonsale.com  
trxonsale.info  
trxonsale.net  
trxonsale.org  
trxonsale.us  
trxonsaleblog.info  
trxontour.com  
trxorders.biz  
trxorders.co  
trxorders.com  
trxorders.net  
trxorders.org  
trxordersonline.info  
trxorderssite.info  
trxordersstore.info  
trxpapers.com  
trxperformances.com  
trxpersonaltrainers.com  
trxpictures.com  
trxpilates.com  
trxpilates.info  
trxpilates.mobi  
trxpilates.net  
trxpilates.tv  
trxpilatesonline.com  
trxpian.com  
trxpianet.com  
trxpower.com  
trxprepare.com  
trxpro.biz  
trxpro.co  
trxpro.info  
trxpro.net

trxpro.org  
trxpro.us  
trxproductioncompany.com  
trxproducts.com  
trxprofessional.com  
trxprofessional.info  
trxprofessionaleducation.com  
trxprogram.com  
trxprogramme.com  
trxprogramming.com  
trxprograms.com  
trxprogramsonline.com  
trxprimo.com  
trxpropack.biz  
trxpropack.com  
trxpropack.info  
trxpropack.me  
trxpropack.mobi  
trxpropack.net  
trxpropack.org  
trxpropack.tv  
trxpropack.us  
trxpropackage.com  
trxpropackonline.com  
trxpros.info  
trxprosite.info  
trxprotraining.com  
trxr4.com  
trxradio.com  
trxradio.net  
trxradio.org  
trxredefined.com  
trxrehab.com  
trxrehabilitation.com  
trxrocks.com  
trxropes.com  
trxroutine.com  
trxrustia.com  
trxsale.com  
trxsaleok.com  
trxsave.biz  
trxsave.co  
trxsave.com  
trxsave.info  
trxsave.net  
trxsave.org  
trxschool.com  
trxschool.com  
trxscastraps.com  
trxsell.info  
trxsell.net  
trxsell.org  
trxserver.com  
trxsf.com

trxsframe.com  
trxsshape.com  
trxsship.com  
trxsshop.biz  
trxsshop.co  
trxsshop.com  
trxsshop.net  
trxsshop.org  
trxsshop.us  
trxsshopping.com  
trxsshopping.info  
trxsshopping.net  
trxsshopping.org  
trxsshops.com  
trxsshow.com  
trxsshred.com  
trxsstite.com  
trxsstingfitness.com  
trxsstingfitness.net  
trxsstolder.com  
trxsstpecial.biz  
trxsstpecial.co  
trxsstpecial.com  
trxsstpecial.info  
trxsstpecial.net  
trxsstpecial.org  
trxsstport.com  
trxsstportsmedicine.com  
trxsstpot.com  
trxsst.com  
trxsststart.com  
trxsstic.com  
trxsstore.biz  
trxsstore.co  
trxsstore.com  
trxsstore.net  
trxsstore.org  
trxsstore.us  
trxsstoreonline.info  
trxsstrap.com  
trxsstraps.info  
trxsstrengthenandconditioning.com  
trxsstressed.com  
trxsstrong.com  
trxsstudios.com  
trxsstuff.com  
trxsstucksblog.info  
trxsstucksnow.info  
trxsstucksonline.info  
trxsstucksshop.info  
trxsstucksite.info  
trxsstuckstoday.info  
trxsstunnt2018.com  
trxsstuperstore.com  
trxsstuspended.com

trx suspension .com  
trx suspension center .com  
trx suspension leader .com  
trx suspension learn .com  
trx suspension online .com  
trx suspension sale .com  
trx suspension tab .com  
trx suspension sale .com  
trx suspension train .com  
trx suspension trainer .com  
trx suspension trainer online .com  
trx suspension trainer professional .com  
trx suspension trainer pro pack .com  
trx suspension trainers .com  
trx suspension trainers .org  
trx suspension training .com  
trx suspension training workout .com  
trx sweat .com  
trx system .biz  
trx system .com  
trx system .info  
trx system .net  
trx system .org  
trx system .us  
trx tactical .com  
trx tactical training .com  
trx taiwan .com  
trx take .com  
trx teach .com  
trx team athletes .com  
trx team captain .com  
trx team coach .com  
trx team store .com  
trx team suspension trainers .com  
trx team suspension training .com  
trx tennis .com  
trx the store .com  
trx thought .com  
trx total body training .com  
trx total training .com  
trx train .biz  
trx train .co  
trx train .info  
trx train .net  
trx train .org  
trx train .us  
trx trainer .com  
trx trainer directory .com  
trx trainer online .com  
trx trainer shop .com  
trx trainer store .com  
trx training .biz  
trx training .cc  
trx training .club  
trx training .co

trtraining.co.uk  
trtraining.com  
trtraining.com.au  
trtraining.com.co  
trtraining.com.co  
trtraining.com.mx  
trtraining.com.lw  
trtraining.es  
trtraining.in  
trtraining.info  
trtraining.jp  
trtraining.live  
trtraining.me  
trtraining.mobi  
trtraining.mx  
trtraining.nl  
trtraining.org  
trtraining.tv  
trtraining.tw  
trtraining.us  
trtraining.vw  
trtrainingaustralia.com.au  
trtrainingblog.info  
trtrainingcamp.com  
trtrainingcenter.com  
trtrainingcenterfrancisco.com  
trtrainingclub.com  
trtrainingcompany.com  
trtrainingnow.info  
trtrainingonline.com  
trtrainingonline.info  
trtrainingpro.biz  
trtrainingpro.co  
trtrainingpro.info  
trtrainingpro.org  
trtrainingproducts.com  
trtrainingprofessional.com  
trtrainingproshop.com  
trtrainingprosite.com  
trtrainingprostore.com  
trtrainingprotoday.com  
trtrainingshop.info  
trtrainingstie.info  
trtrainingspace.com  
trtrainingstore.info  
trtrainingsystems.com  
trtrainingsystem.com  
trtrainingtoday.info  
trtrainingzone.com  
trtrainingzone.com  
trtrainingzone.info  
trtrains.info  
trtrainstie.info  
trtrainzone.com  
trtrend.com

trxtrihlete.com  
trxiv.co  
trxiv.com  
trxiv.net  
trxiv.org  
trxtz.com  
trxuniversal.com  
trxuniverse.com  
trxvectorresistance.com  
trxvideo.biz  
trxvideo.com  
trxvideo.info  
trxvideo.net  
trxvideo.org  
trxvideoblog.com  
trxvideonow.com  
trxvideoonline.com  
trxvideoshop.com  
trxvideo.site.com  
trxvideostore.com  
trxvirtualpersonaltraining.com  
trxvisuals.com  
trxvpl.com  
trxwarehouse.com  
trxwebstore.com  
trxweight.com  
trxworkout.com  
trxworkout.info  
trxworkoutonline.info  
trxworkouts.com  
trxworkoutcentral.com  
trxworkoutshop.info  
trxworkoutsonline.com  
trxworkoutstore.info  
trxworkouttoday.info  
trxworldwide.com  
trxyoga.com  
trxyoga.mobi  
trxyoga.net  
trxyoga.org  
trxyoga.tv  
trxyogasonline.com  
trxyogas.com  
trxyouthtraining.com  
trxzone.com  
trxzone.info  
tryalrx.com  
trc-trainers.com  
trxtrainingzone.com  
ultimateoutdoorworkout.com  
ultimateoutdoorworkout.net  
universalrx.com  
uniwersetrx.com  
vector-resistance.com  
vectorresistance.com



vectorresistancetraining.com  
vortextraining.com  
vrxfitness.com  
vrtraining.com  
wartiortrx.com  
webbodylever.com  
webbodyleverage.com  
webbodyweightleverage.com  
webbodyweightleverageexercise.com  
webgraviditytraining.com  
websuspensionbased.com  
websuspensionbasedtraining.com  
webtrxbootcamp.com  
webtrxfitness.com  
webtrxxkettlebell.com  
webtrxpropack.com  
webtrxtraining.com  
webtrxworkouts.com  
weightkettlebell.com  
whatistrx.com  
whatistrxstance.com  
whatistrx.com  
workoutsuspension.com  
workouttrxfitness.com  
yellowandblackstraps.com  
yogatrxxworkouts.com  
youthbodyisyourmachine.com  
yourtretrx.com  
yourtrx.com  
yourtrxbootcamp.com  
yourtrxkettlebell.com  
Go Daddy  
MEUNEGGOCIOTRX.COM.BR  
rxtraining.co.za  
TRXTRAINING.IT