

TRADEMARK ASSIGNMENT COVER SHEET

Electronic Version v1.1
Stylesheet Version v1.2

ETAS ID: TM780010

SUBMISSION TYPE:	RESUBMISSION		
NATURE OF CONVEYANCE:	SECURITY INTEREST		
RESUBMIT DOCUMENT ID:	900734502		
CONVEYING PARTY DATA			
Name	Formerly	Execution Date	Entity Type
ScriptDrop		06/29/2022	Corporation: DELAWARE
RECEIVING PARTY DATA			
Name:	Celtic Bank Corporation		
Street Address:	268 S State St		
City:	Salt Lake City		
State/Country:	UTAH		
Postal Code:	84111		
Entity Type:	Corporation: UTAH		
PROPERTY NUMBERS Total: 1			
Property Type	Number	Word Mark	
Serial Number:	87842200	SCRIPTDROP	
CORRESPONDENCE DATA			
Fax Number:			
<i>Correspondence will be sent to the e-mail address first; if that is unsuccessful, it will be sent using a fax number, if provided; if that is unsuccessful, it will be sent via US Mail.</i>			
Phone:	8013206588		
Email:	lrinaldi@celticbank.com		
Correspondent Name:	Leslie Rinaldi		
Address Line 1:	268 S State St		
Address Line 2:	Ste 300		
Address Line 4:	Salt Lake City, UTAH 84111		
NAME OF SUBMITTER:	Leslie K Rinaldi		
SIGNATURE:	// Leslie K Rinaldi //		
DATE SIGNED:	01/11/2023		
Total Attachments: 15			
source=062922 17500362 IP Security Agreement#page1.tif			
source=062922 17500362 IP Security Agreement#page2.tif			
source=062922 17500362 IP Security Agreement#page3.tif			
source=062922 17500362 IP Security Agreement#page4.tif			

source=062922 17500362 IP Security Agreement#page5.tif
source=062922 17500362 IP Security Agreement#page6.tif
source=062922 17500362 IP Security Agreement#page7.tif
source=062922 17500362 IP Security Agreement#page8.tif
source=062922 17500362 IP Security Agreement#page9.tif
source=062922 17500362 IP Security Agreement#page10.tif
source=062922 17500362 IP Security Agreement#page11.tif
source=062922 17500362 IP Security Agreement#page12.tif
source=062922 17500362 IP Security Agreement#page13.tif
source=062922 17500362 IP Security Agreement#page14.tif
source=062922 17500362 IP Security Agreement#page15.tif

Loan #: 17500362

Principal Loan Amount: \$12,500,000.00

INTELLECTUAL PROPERTY SECURITY AGREEMENT

This INTELLECTUAL PROPERTY SECURITY AGREEMENT ("**IP Security Agreement**"), dated as of June 29, 2022 is made by and ScriptDrop, Inc. a Delaware corporation authorized to do business in the state of Utah ("Borrower") in favor of Celtic Bank Corporation (the "**Lender**"), a Utah state corporation.

WHEREAS, the Borrower has entered into Business Loan Agreements dated as of even date (the "Loan Agreement"), with the Lender; and

WHEREAS, as a condition precedent to the making of the loan by the Lender under the Loan Agreement, Borrower has executed and delivered to the Lender that certain Security Agreement dated as of June 29, 2022 made by and among the Borrower and the Lender (the "Security Agreement"); and

WHEREAS, under the terms of the Security Agreement, the Borrower has granted to the Lender a security interest in, among other property, certain intellectual property of the Borrower and has agreed to execute and deliver this IP Security Agreement for recording with governmental authorities, including, but not limited to, the United States Patent and Trademark Office and the United States Copyright Office.

NOW THEREFORE, for good and valuable consideration, the receipt and sufficiency of which are hereby acknowledged, the parties agree as follows:

1. Grant of Security. Borrower hereby pledges and grants to the Lender a security interest in and to all of the right, title, and interest of Borrower in, to, and under the following (the "IP Collateral"):

- (a) the patents and patent applications set forth in Schedule 1 hereto and all reissues, divisions, continuations, continuations-in-part, renewals, extensions, and reexaminations thereof and amendments thereto (the "**Patents**");
- (b) the trademark registrations and applications set forth in Schedule 2 hereto, together with the goodwill connected with the use thereof and symbolized thereby, and all extensions and renewals thereof (the "**Trademarks**");
- (c) all rights of any kind whatsoever of Grantor accruing under any of the foregoing provided by applicable law of any jurisdiction, by international treaties and conventions, and otherwise throughout the world;
- (e) any and all royalties, fees, income, payments, and other proceeds now or hereafter due or payable with respect to any and all of the foregoing; and
- (f) any and all claims and causes of action with respect to any of the foregoing, whether occurring before, on, or after the date hereof, including all rights to and claims for damages, restitution, and injunctive and other legal and equitable relief for past, present, and future infringement, dilution, misappropriation, violation, misuse, breach, or default, with the right, but no obligation, to sue for such legal and equitable relief and to collect, or otherwise recover, any such damages.

2. Recordation. Borrower authorizes the Commissioner for Patents to record and register this IP Security Agreement upon request by the Lender.

3. Loan Documents. This IP Security Agreement has been entered into pursuant to and in conjunction with the Security Agreement, which is hereby incorporated by reference. The provisions of the Security Agreement shall supersede and control over any conflicting or inconsistent provision herein. The rights and remedies of the Lender with respect to the IP Collateral are as provided by the Loan Agreement, the Security Agreement, and related documents, and nothing in this IP Security Agreement shall be deemed to limit such rights and remedies.

Loan #: 17500362

Principal Loan Amount: \$12,500,000.00

4. Execution in Counterparts. This IP Security Agreement may be executed in counterparts (and by different parties hereto in different counterparts), each of which shall constitute an original, but all of which when taken together shall constitute a single contract. Delivery of an executed counterpart of a signature page to this IP Security Agreement by facsimile or in electronic (i.e., "pdf" or "tif") format shall be effective as delivery of a manually executed counterpart of this IP Security Agreement.

5. Successors and Assigns. This IP Security Agreement will be binding on and shall inure to the benefit of the parties hereto and their respective successors and assigns.

6. Governing Law. This IP Security Agreement and any claim, controversy, dispute, or cause of action (whether in contract or tort or otherwise) based upon, arising out of, or relating to this IP Security Agreement and the transactions contemplated hereby and thereby shall be governed by, and construed in accordance with, the laws of the United States and the State of Utah, without giving effect to any choice or conflict of law provision or rule (whether of the State of Utah or any other jurisdiction).

IN WITNESS WHEREOF, Borrower has caused this IP Security Agreement to be duly executed and delivered by its officer thereunto duly authorized as of the date first above written.

SCRIPTDROP, INC.

DocuSigned by:
By: Amanda Epp
FD1BC9DBE33F45F...

Name: Amanda Epp

Title: Chief Executive Officer

Address for Notices:

855 Grandview Ave., Suite 110
Columbus, OH 43215

Loan #: 17500362

Principal Loan Amount: \$12,500,000.00

AGREED TO AND ACCEPTED:

CELTIC BANK CORPORATION

DocuSigned by:
By: Daniel Godfrey
-----B2819D5CA2FE460-----

Name: Daniel Godfrey

Title: Senior Vice President

Address for Notices:

268 S. State Street, Suite 300
Salt Lake City, UT 84111

Loan #: 17500362

Principal Loan Amount: \$12,500,000.00

SCHEDULES

SCHEDULE 1

PATENTS

Title	Jurisdiction	Patent Number	Issue/Filing Date	[Record Owner]
SYSTEMS AND METHODS FOR PROVIDING PRESCRIPTION MEDICATION DELIVERY AND REMINDER SERVICES	United States	10,741,276	August 11, 2020	ScriptDrop, Inc.
SYSTEMS AND METHODS FOR PROVIDING PRESCRIPTION MEDICATION DELIVERY AND REMINDER SERVICES	United States	11,276,487	March 15, 2022	ScriptDrop, Inc.

Loan #: 17500362

Principal Loan Amount: \$12,500,000.00

SCHEDULE 2
TRADEMARKS

Word Mark	Jurisdiction	Serial Number / Registration Number	Filing Date / Registration Date	[Record Owner]
SCRIPTDROP	United States	87842200 / 5590159	March 20, 2018 / October 23, 2018	ScriptDrop, Inc.



(12) **United States Patent**
Potts

(10) **Patent No.:** **US 11,276,487 B2**
(45) **Date of Patent:** **Mar. 15, 2022**

(54) **SYSTEMS AND METHODS FOR PROVIDING PRESCRIPTION MEDICATION DELIVERY AND REMINDER SERVICES**

(71) Applicant: **ScriptDrop, Inc.**, Nashville, TN (US)

(72) Inventor: **Nicholas Potts**, Nashville, TN (US)

(73) Assignee: **ScriptDrop, Inc.**, Nashville, TN (US)

(*) Notice: Subject to any disclaimer, the term of this patent is extended or adjusted under 35 U.S.C. 154(b) by 0 days.

(21) Appl. No.: **16/989,867**

(22) Filed: **Aug. 10, 2020**

(65) **Prior Publication Data**

US 2020/0372994 A1 Nov. 26, 2020

Related U.S. Application Data

(63) Continuation of application No. 16/398,876, filed on Apr. 30, 2019, now Pat. No. 10,741,276, which is a continuation-in-part of application No. 15/969,663, filed on May 2, 2018.

(Continued)

(51) **Int. Cl.**

G16H 40/20 (2018.01)

G16H 20/13 (2018.01)

(Continued)

(52) **U.S. Cl.**

CPC **G16H 20/13** (2018.01); **G16H 40/20** (2018.01); **G16H 80/00** (2018.01); **H04L 67/02** (2013.01); **H04L 67/12** (2013.01); **H04L 67/26** (2013.01)

(58) **Field of Classification Search**

CPC G16H 20/13; G16H 40/20; G16H 80/00; G16H 20/10; G16H 40/67; G16H 10/60;

(Continued)

(56) **References Cited**

U.S. PATENT DOCUMENTS

5,845,255 A 12/1998 Mayaud
10,289,806 B2 5/2019 Hyde et al.

(Continued)

FOREIGN PATENT DOCUMENTS

CN 106456446 A 2/2017
KR 1020020061445 A 7/2002
KR 1020060087752 A 8/2006

OTHER PUBLICATIONS

Search Report and Written Opinion in corresponding International application No. PCT/US2018/030818, dated Sep. 14, 2018, 12 pages.

(Continued)

Primary Examiner — Maroun P Kanaan

(74) *Attorney, Agent, or Firm* — Patterson Intellectual Property Law, P.C.

(57) **ABSTRACT**

Novel systems, methods, and devices for implementing prescription delivery and for providing medication reminders are provided. One system for providing a prescription medication delivery service operates by a server configured to receive a requested delivery signal including delivery coordinator information and prescription medication information. A physician device receives input relating to a selection of a prescription delivery option within a pharmacy dispensing system and transmits a corresponding request message associated with the prescription delivery option via the communication network. A prescription delivery service server configured receives the request message via the communication network and coordinates delivery of the prescription medication based at least in part upon the delivery coordinator and the prescription medication information.

13 Claims, 6 Drawing Sheets

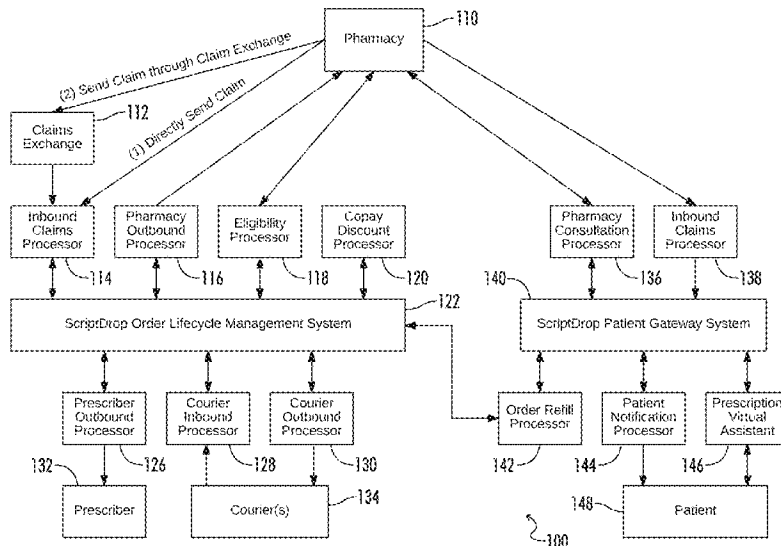



(12) **United States Patent**
Potts

(10) **Patent No.:** **US 10,741,276 B2**
(45) **Date of Patent:** **Aug. 11, 2020**

(54) **SYSTEMS AND METHODS FOR PROVIDING PRESCRIPTION MEDICATION DELIVERY AND REMINDER SERVICES**

(71) Applicant: **ScriptDrop, Inc.**, Nashville, TN (US)

(72) Inventor: **Nicholas Potts**, Nashville, TN (US)

(73) Assignee: **ScriptDrop, Inc.**, Nashville, TN (US)

(*) Notice: Subject to any disclaimer, the term of this patent is extended or adjusted under 35 U.S.C. 154(b) by 0 days.

(21) Appl. No.: **16/398,876**

(22) Filed: **Apr. 30, 2019**

(65) **Prior Publication Data**

US 2019/0259483 A1 Aug. 22, 2019

Related U.S. Application Data

(63) Continuation-in-part of application No. 15/969,663, filed on May 2, 2018.
(Continued)

(51) **Int. Cl.**
G16H 20/13 (2018.01)
G16H 40/20 (2018.01)
(Continued)

(52) **U.S. Cl.**
CPC **G16H 20/13** (2018.01); **G16H 40/20** (2018.01); **G16H 80/00** (2018.01); **H04L 67/02** (2013.01); **H04L 67/12** (2013.01); **H04L 67/26** (2013.01)

(58) **Field of Classification Search**
CPC G06Q 50/24; G06Q 10/10; G06Q 30/0635; G06Q 10/087; G06Q 10/06;
(Continued)

(56) **References Cited**

U.S. PATENT DOCUMENTS

5,845,255 A 12/1998 Mayaud
10,289,806 B2 5/2019 Hyde et al.
(Continued)

FOREIGN PATENT DOCUMENTS

CN 106456446 A 2/2017
KR 1020020061445 A 7/2002
KR 1020060087752 A 8/2006

OTHER PUBLICATIONS

Search Report and Written Opinion in corresponding international application No. PCT/US2018/030818, dated Sep. 14, 2018, 12 pages.

(Continued)

Primary Examiner — Maroun P Kanaan
(74) *Attorney, Agent, or Firm* — Patterson Intellectual Property Law, P.C.; Grant M. Ford

(57) **ABSTRACT**

Novel systems, methods, and devices for implementing prescription delivery and for providing medication reminders are provided. One system for providing a prescription medication delivery service operates by directly submitting a prescription delivery request to the prescription medication delivery service. A server may receive a requesting delivery signal related to a prescription medication via a communication network. A physician device may receive input relating to a selection of a prescription delivery option within a pharmacy dispensing system and transmit a corresponding message via the communication network. A prescription delivery service server may receive the message and coordinate delivery of the prescription medication based at least in part upon the message. An electronic device may obtain a confirmation indication when the prescription medication is delivered and transmit a confirmation of completed delivery.

5 Claims, 6 Drawing Sheets

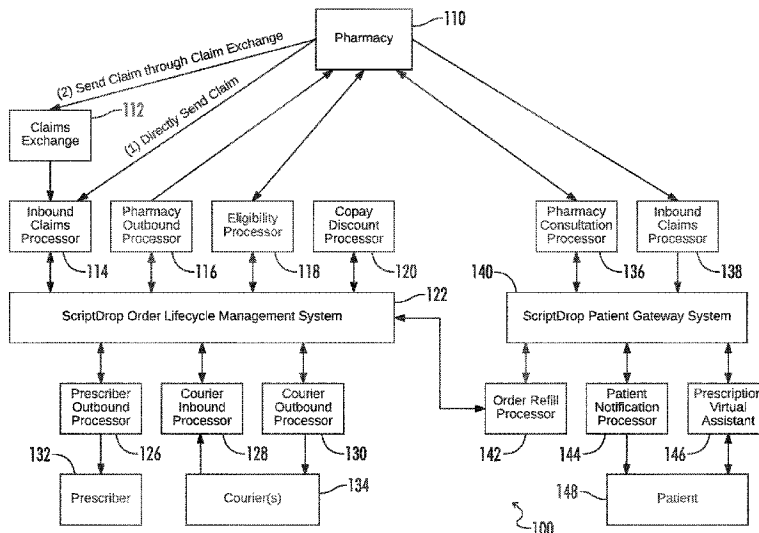

US 10,741,276 B2

Related U.S. Application Data

(60) Provisional application No. 62/500,861, filed on May 3, 2017.

2015/0134107 A1 5/2015 Hyde et al.
2016/0292378 A1 10/2016 Saric
2018/0075215 A1* 3/2018 Loiacono G06F 19/3462

(51) **Int. Cl.**

H04L 29/08 (2006.01)

G16H 80/00 (2018.01)

(58) **Field of Classification Search**

CPC G06F 19/3456; G06F 19/326; G06F 19/3418; G06F 19/00; G06F 19/328; G06F 19/3462; G06F 19/3481; G06F 19/321; G16H 20/10; G16H 10/60
See application file for complete search history.

OTHER PUBLICATIONS

Google search directing submitting prescription delivery request to delivery service using identification, dated Feb. 7, 2020, 2 pages, as cited in co-pending U.S. Appl. No. 15/969,663 and provided to Applicant on Feb. 20, 2020.

NCPDP: Testimony to NCVHS, Session A1: Proposals for a National Health Plan Identifier, dated Jul. 19, 2020, 4 pages, as cited in co-pending U.S. Appl. No. 15/969,663 and provided to Applicant on Feb. 20, 2020.

(56) **References Cited**

U.S. PATENT DOCUMENTS

2006/0122729 A1 6/2006 Murphy et al.
2012/0179480 A1* 7/2012 Patel G06Q 50/22
705/2

* cited by examiner

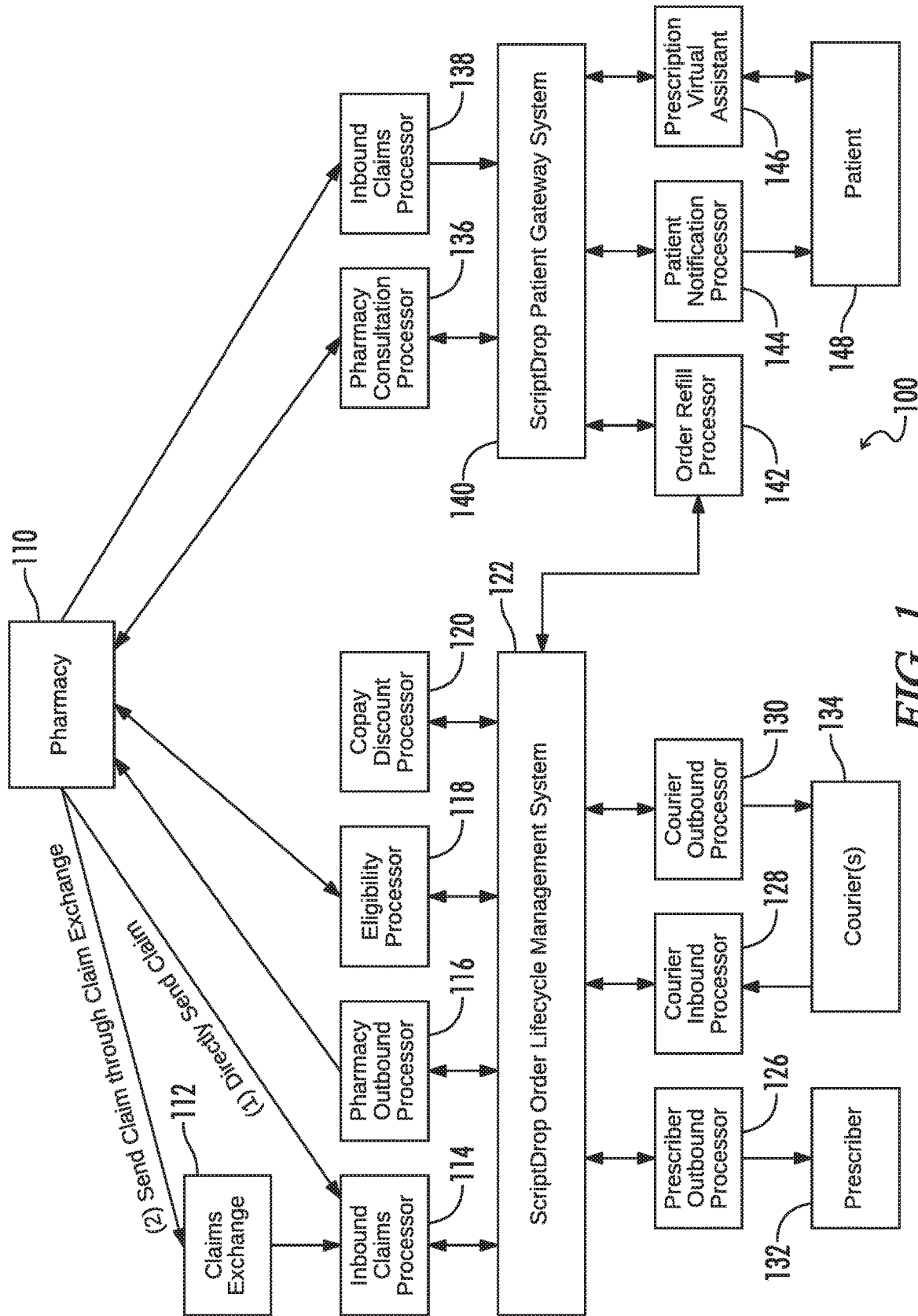

FIG. 1

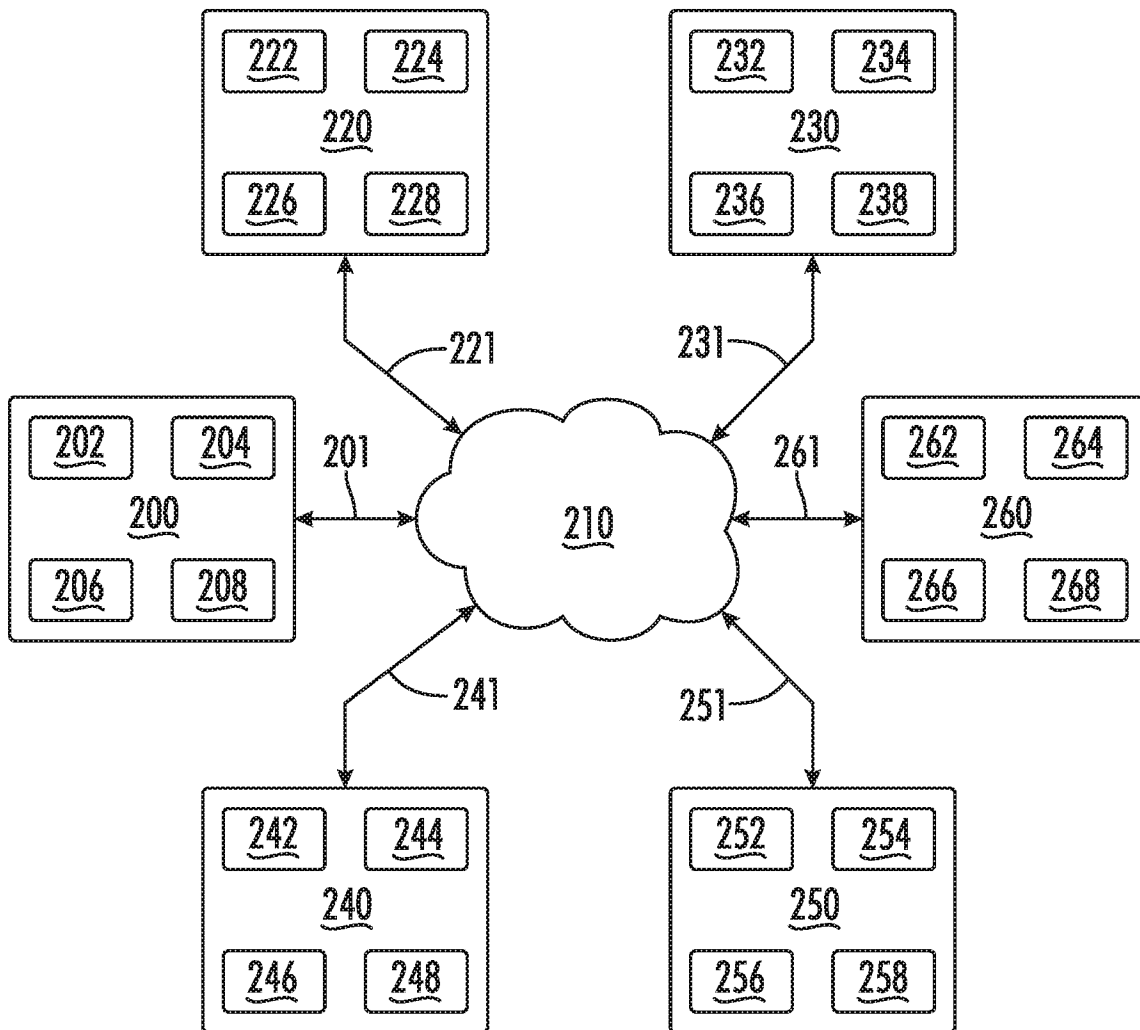

FIG. 2

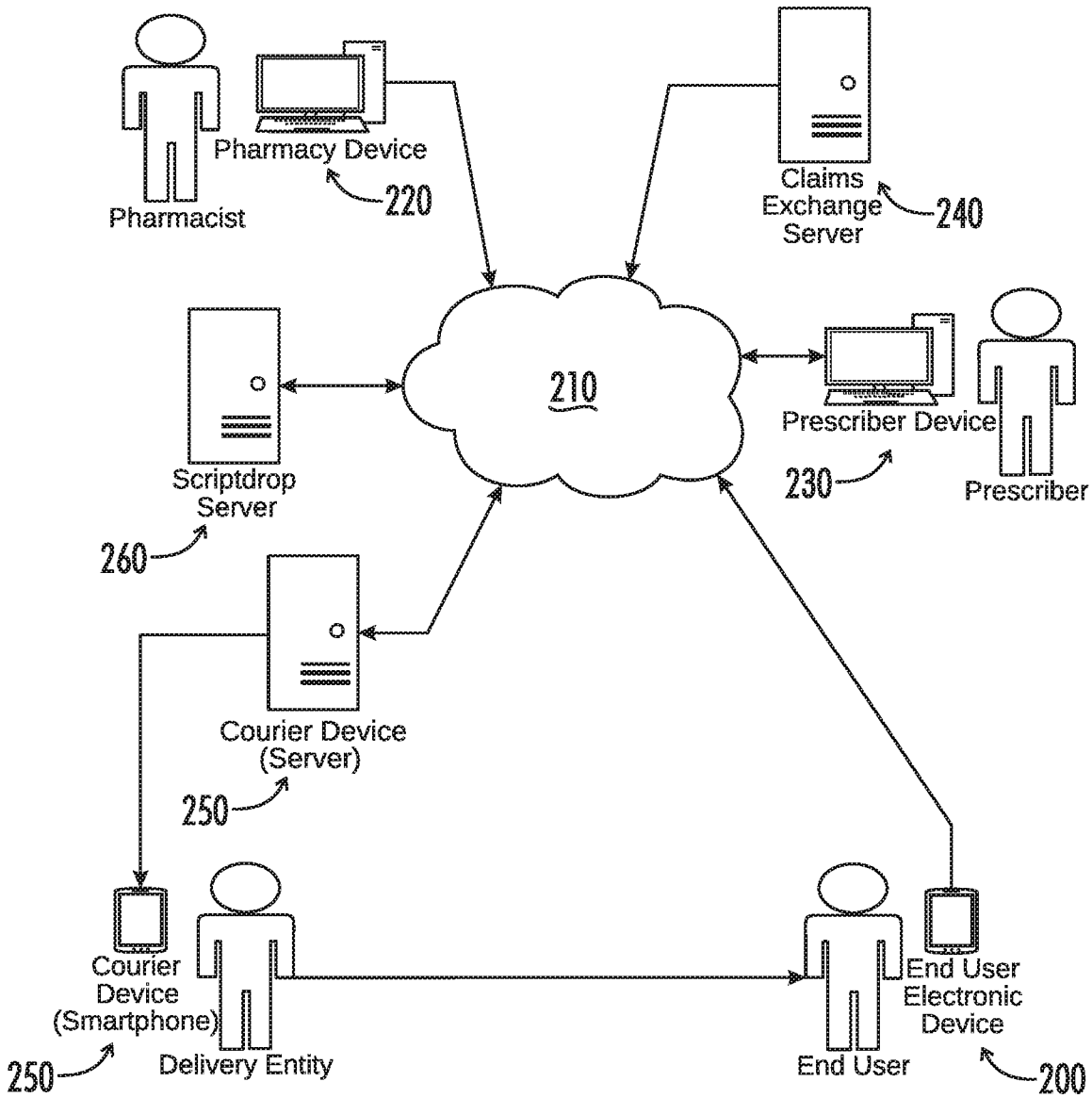
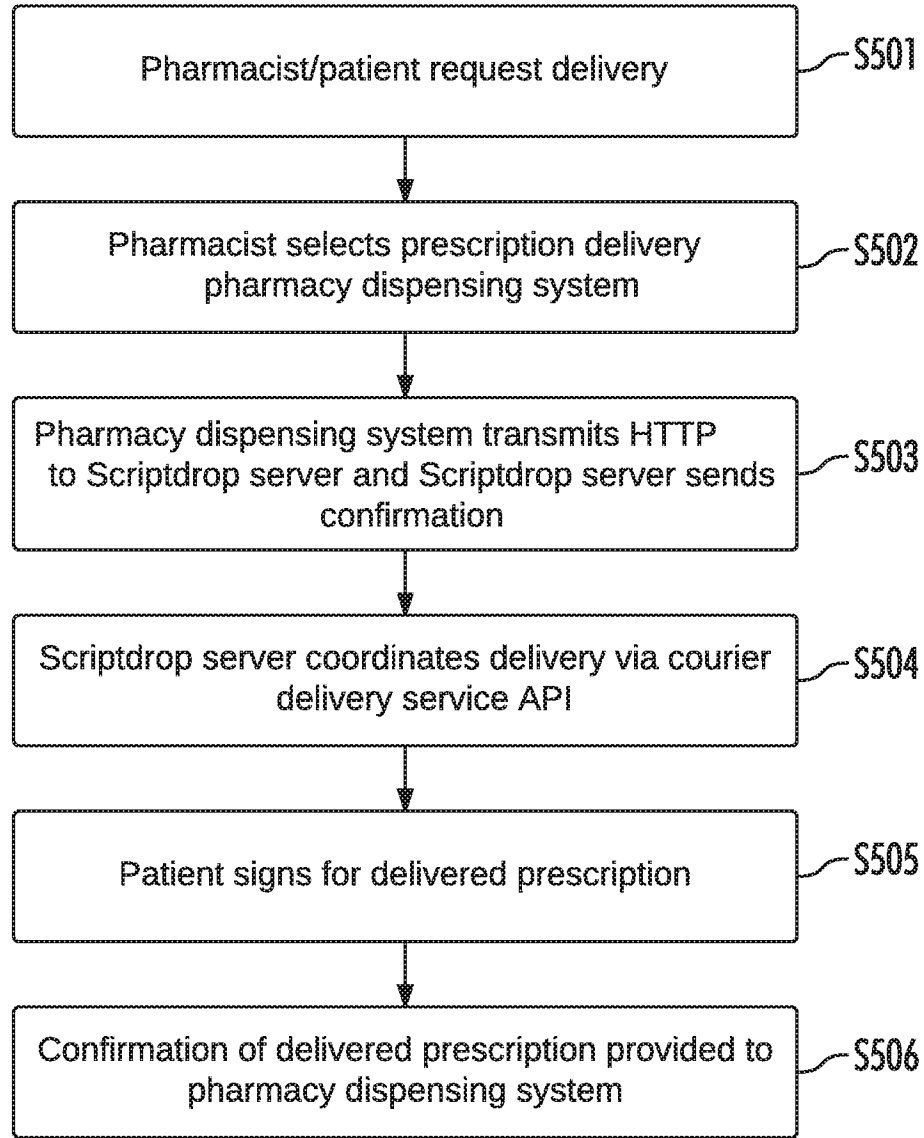

FIG. 3

101-A1	BIN
102-A2	Version
103-A3	Transaction Code
104-A4	Processor Control Number
109-A9	Transaction Count
110-AK	Software Vendor/Certification ID
111-AM	Segment Identification
201-B1	Service Provider ID Qualifier
202-B2	Service Provider ID
301-C1	Group ID
302-C2	Cardholder ID
303-C3	Person Code
304-C4	Date of Birth
305-C5	Patient Gender Code
306-C6	Patient Relationship Code
310-CA	Patient First Name
311-CB	Patient Last Name
322-CM	Patient Street Address
323-CN	Patient City Address
324-CO	Patient State/Province Code
325-CP	Patient Zip/Postal Code
401-D1	Date of Service
402-D2	Prescription/Service Reference Number
405-D5	Days' Supply
407-D7	Product/Service ID
411-DB	Prescriber ID
427-DR	Prescriber Last Name
436-E1	Product/Service ID Qualifier
442-E7	Quantity Dispensed
455-EM	Prescription/Service Reference Number Qualifier
466-EZ	Prescriber ID Qualifier
337-4C	Coordination of Benefits/Other Payments Count
338-5C	Other Payer Coverage Type
353-NR	Other Payer-Patient Responsibility Amount Count
340-7C	Other Payer ID
339-6C	Other Payer ID Qualifier
351-NP	Other Payer-Patient Responsibility Amount Qualifier
352-NQ	Other Payer-Patient Responsibility Amount
433-DX	Patient Paid Amount Submitted
430-DU	Gross Amount Due
403-D3	Fill Number
415-DF	Number of Refills Authorized

FIG. 4



500 ↗

FIG. 5

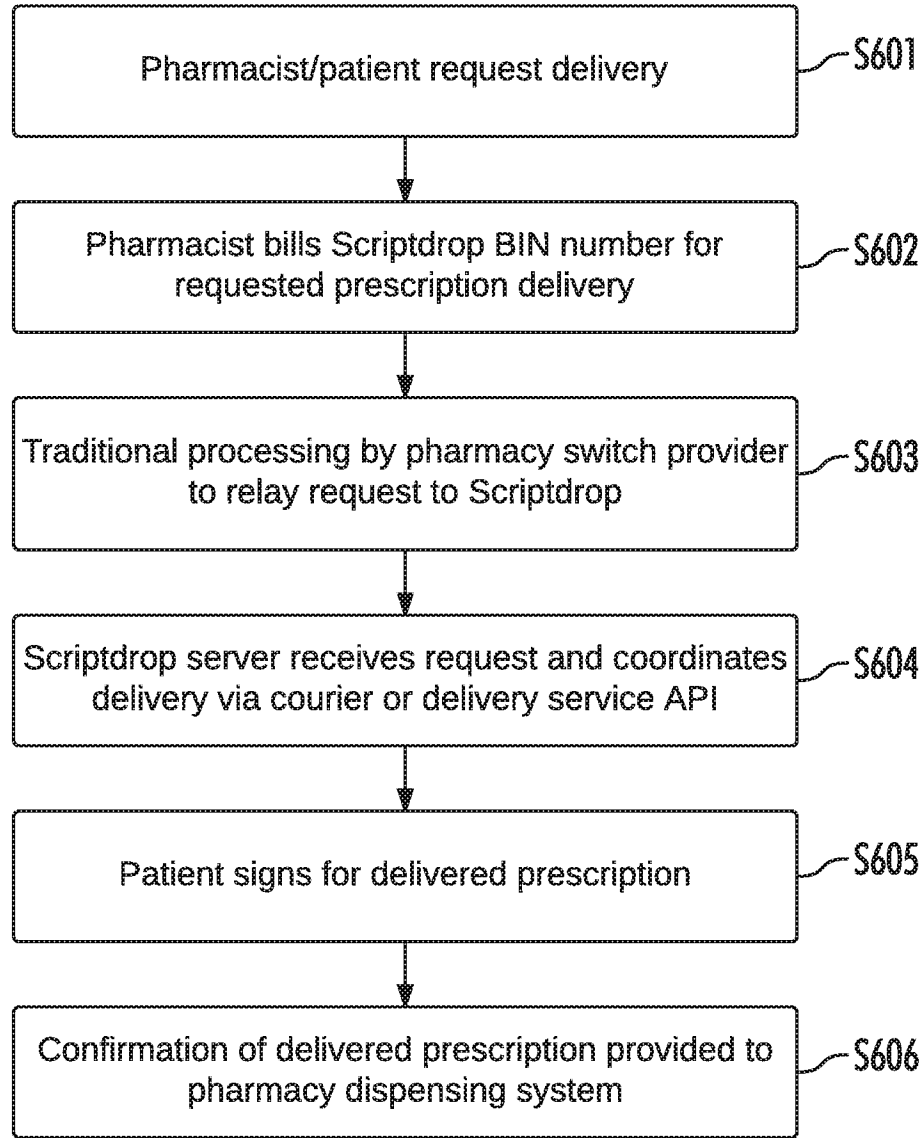

600 ↗

FIG. 6



United States Patent and Trademark Office

[Home](#) | [Site Index](#) | [Search](#) | [FAQ](#) | [Glossary](#) | [Contacts](#) | [eBusiness](#) | [eBiz alerts](#) | [News](#)

Trademarks > Trademark Electronic Search System (TESS)

TESS was last updated on Tue May 17 03:47:22 EDT 2022

[TESS Home](#) | [NEW USER](#) | [STRUCTURED](#) | [FREE FORM](#) | [Browser Help](#) | [SEARCH QC](#) | [BOTTOM](#) | [HELP](#)[Logout](#) Please logout when you are done to release system resources allocated for you.

Record 1 out of 1

[TSDR](#) | [ASSIGN Status](#) | [TTAB Status](#) (Use the "Back" button of the Internet Browser to return to TESS)

ScriptDrop

Word Mark SCRIPTDROP**Goods and Services** IC 039. US 100 105. G & S: Distribution services, namely, delivery of prescribed pharmaceuticals and other medicinal drugs. FIRST USE: 20160325. FIRST USE IN COMMERCE: 20180103

IC 042. US 100 101. G & S: Software as a service (SAAS) services featuring software for prescription adherence management in the field of pharmaceutical drugs. FIRST USE: 20160325. FIRST USE IN COMMERCE: 20180103

Standard Characters Claimed**Mark Drawing Code** (4) STANDARD CHARACTER MARK**Serial Number** 87842200**Filing Date** March 20, 2018**Current Basis** 1A**Original Filing Basis** 1A**Published for Opposition** August 7, 2018**Registration Number** 5590159**Registration Date** October 23, 2018**Owner** (REGISTRANT) ScriptDrop, Inc. CORPORATION DELAWARE 331 E Thompson LN Nashville TENNESSEE 37211**Attorney of Record** Kelcy Morris**Type of Mark** SERVICE MARK**Register** PRINCIPAL**Live/Dead Indicator** LIVE